

# JVC



## COMPACT VHS CAMCORDER

# GR-AX840

ENGLISH

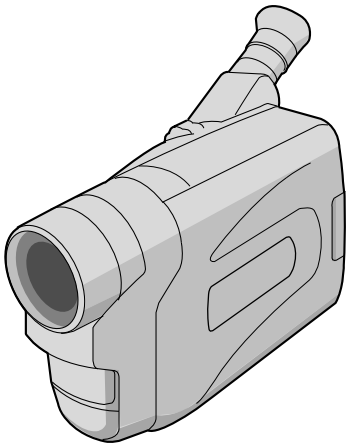

*Compact VHS*



## INSTRUCTIONS

**For Customer Use:**

Enter below the Model No. and Serial No. which is located on the bottom of cabinet. Retain this information for future reference.

Model No. \_\_\_\_\_

Serial No. \_\_\_\_\_

LYT0251-001B

**EN**

**Dear Customer,**

Thank you for purchasing the JVC Compact VHS camcorder. Before use, please read the safety information and precautions contained in the following pages to ensure safe use of this product.

**Using This Instruction Manual**



- All major sections and subsections are listed in the Table Of Contents (☞ pg. 7).
- Notes appear after most subsections. Be sure to read these as well.
- Basic and advanced features/operation are separated for easier reference.

**It is recommended that you . . .**

- ..... refer to the Index (☞ pgs. 45 – 48) and familiarize yourself with button locations, etc. before use.
- ..... read thoroughly the Safety Precautions and Safety Instructions that follow. They contain extremely important information regarding the safe use of this product.

You are recommended to carefully read the cautions on pages 49 and 50 before use.

## SAFETY PRECAUTIONS

	<b>CAUTION</b> RISK OF ELECTRIC SHOCK DO NOT OPEN	
<b>CAUTION:</b> TO REDUCE THE RISK OF ELECTRIC SHOCK, DO NOT REMOVE COVER (OR BACK). NO USER-SERVICEABLE PARTS INSIDE. REFER SERVICING TO QUALIFIED SERVICE PERSONNEL.		



The lightning flash with arrowhead symbol, within an equilateral triangle, is intended to alert the user to the presence of uninsulated "dangerous voltage" within the product's enclosure that may be of sufficient magnitude to constitute a risk of electric shock to persons.



The exclamation point within an equilateral triangle is intended to alert the user to the presence of important operating and maintenance (servicing) instructions in the literature accompanying the appliance.

The AA-V15U AC Power Adapter/Charger should be used with:

AC 120 V~, 60 Hz in the USA and Canada,  
AC 110 – 240 V~, 50/60 Hz in other countries.

**CAUTION (applies to the AA-V15U)**

TO PREVENT ELECTRIC SHOCK MATCH WIDE BLADE OF PLUG TO WIDE SLOT, FULLY INSERT.

**ATTENTION (s'applique à l'AA-V15U)**

POUR ÉVITER LES CHOCs ÉLECTRIQUES, INTRODUIRE LA LAME LA PLUS LARGE DE LA FICHE DANS LA BORNE CORRESPONDANTE DE LA PRISE ET POUSSER JUSQU'AU FOND.

**WARNING:**

**TO PREVENT FIRE OR SHOCK HAZARD, DO NOT EXPOSE THIS UNIT TO RAIN OR MOISTURE.**

**Warning on lithium battery (for clock operation)**

The battery used in this device may present a fire or chemical burn hazard if mistreated. Do not recharge, disassemble, heat above 100°C (212°F) or incinerate.

Replace the battery with Maxell, Panasonic (Matsushita Electric), Sanyo or Sony CR2025; use of another battery may present a risk of fire or explosion.

- Dispose of used battery promptly.
- Keep away from children.
- Do not disassemble and do not dispose of in fire.

**NOTES:**

- The rating plate (serial number plate) and safety caution are on the bottom and/or the back of the main unit.
- The rating plate (serial number plate) of the AC Power Adapter/Charger is on its bottom.

This Class B digital apparatus complies with Canadian ICES-003

Cet appareil numérique de la classe B est conforme à la norme NMB-003 du Canada.

This camcorder is designed to be used with NTSC-type color television signals. It cannot be used for playback with a television of a different standard. However, live recording and viewfinder playback are possible anywhere. Use the BN-V11U/V12U/V20U battery packs and, to recharge them, the provided multi-voltage AC Power Adapter/Charger. (An appropriate conversion adapter may be necessary to accommodate different designs of AC outlets in different countries.)

**ATTENTION:**

The product that you have purchased is powered by a rechargeable battery. The battery is recyclable. At the end of its useful life, under various state and local laws, it may be illegal to dispose of this battery into the municipal waste stream. Check with your local solid waste officials for details in your area for recycling options or proper disposal.

# IMPORTANT PRODUCT SAFETY INSTRUCTIONS

Electrical energy can perform many useful functions. But improper use can result in potential electrical shock or fire hazards. This product has been engineered and manufactured to assure your personal safety. In order not to defeat the built-in safeguards, observe the following basic rules for its installation, use and servicing.

## ATTENTION:

Follow and obey all warnings and instructions marked on your product and its operating instructions. For your safety, please read all the safety and operating instructions before you operate this product and keep this manual for future reference.

## INSTALLATION

### 1. Grounding or Polarization

- (A) Your product may be equipped with a polarized alternating-current line plug (a plug having one blade wider than the other). This plug will fit into the power outlet only one way. This is a safety feature. If you are unable to insert the plug fully into the outlet, try reversing the plug. If the plug should still fail to fit, contact your electrician to replace your obsolete outlet. Do not defeat the safety purpose of the polarized plug.
- (B) Your product may be equipped with a 3-wire grounding-type plug, a plug having a third (grounding) pin. This plug will only fit into a grounding-type power outlet. This is a safety feature. If you are unable to insert the plug into the outlet, contact your electrician to replace your obsolete outlet. Do not defeat the safety purpose of the grounding-type plug.

### 2. Power Sources

Operate your product only from the type of power source indicated on the marking label. If you are not sure of the type of power supply to your home, consult your product dealer or local power company. If your product is intended to operate from battery power, or other sources, refer to the operating instructions.

### 3. Overloading

Do not overload wall outlets, extension cords, or integral convenience receptacles as this can result in a risk of fire or electric shock.

### 4. Power Cord Protection

Power supply cords should be routed so that they are not likely to be walked on or pinched by items placed upon or against them, paying particular attention to cords at plugs, convenience receptacles, and the point where they exit from the product.

### 5. Ventilation

Slots and openings in the cabinet are provided for ventilation. To ensure reliable operation of the product and to protect it from overheating, these openings must not be blocked or covered.

- Do not block the openings by placing the product on a bed, sofa, rug or other similar surface.
- Do not place the product in a built-in installation such as a bookcase or rack unless proper ventilation is provided or the manufacturer's instructions have been adhered to.

### 6. Wall or Ceiling Mounting

The product should be mounted to a wall or ceiling only as recommended by the manufacturer.

## ANTENNA INSTALLATION INSTRUCTIONS

### 1. Outdoor Antenna Grounding

If an outside antenna or cable system is connected to the product, be sure the antenna or cable system is grounded so as to provide some protection against voltage surges and built-up static charges. Article 810 of the National Electrical Code, ANSI/NFPA 70, provides information with regard to proper grounding of the mast and supporting structure, grounding of the lead-in wire to an antenna discharge unit, size of grounding conductors, location of antenna discharge unit, connection to grounding electrodes, and requirements for the grounding electrode.

### 2. Lightning

For added protection for this product during a lightning storm, or when it is left unattended and unused for long periods of time, unplug it from the wall outlet and disconnect the antenna or cable system. This will prevent damage to the product due to lightning and power-line surges.

### 3. Power Lines

An outside antenna system should not be located in the vicinity of overhead power lines or other electric light or power circuits, or where it can fall into such power lines or circuits. When installing an outside antenna system, extreme care should be taken to keep from touching such power lines or circuits as contact with them might be fatal.

#### EXAMPLE OF ANTENNA GROUNDING AS PER NATIONAL ELECTRICAL CODE, ANSI/NFPA 70

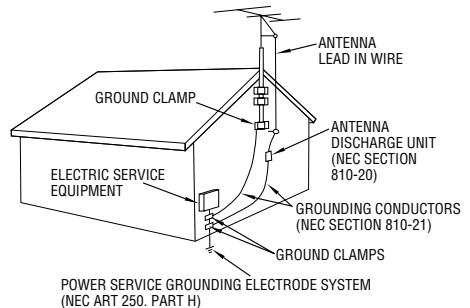

NEC - NATIONAL ELECTRICAL CODE

## USE

### 1. Accessories

#### To avoid personal injury:

- Do not place this product on an unstable cart, stand, tripod, bracket or table. It may fall, causing serious injury to a child or adult, and serious damage to the product.
- Use only with a cart, stand, tripod, bracket, or table recommended by the manufacturer or sold with the product.
- Use a mounting accessory recommended by the manufacturer and follow the manufacturer's instructions for any mounting of the product.
- Do not try to roll a cart with small casters across thresholds or deep-pile carpets.

### 2. Product and Cart Combination

A product and cart combination should be moved with care. Quick stops, excessive force, and uneven surfaces may cause the product and cart combination to overturn.

**PORTABLE CART WARNING**  
(Symbol provided by RETAC)



### 3. Water and Moisture

Do not use this product near water—for example, near a bath tub, wash bowl, kitchen sink or laundry tub, in a wet basement, or near a swimming pool and the like.

### 4. Object and Liquid Entry

Never push objects of any kind into this product through openings as they may touch dangerous voltage points or short-out parts that could result in a fire or electric shock. Never spill liquid of any kind on the product.

### 5. Attachments

Do not use attachments not recommended by the manufacturer of this product as they may cause hazards.

### 6. Cleaning

Unplug this product from the wall outlet before cleaning. Do not use liquid cleaners or aerosol cleaners. Use a damp cloth for cleaning.

### 7. Heat

The product should be situated away from heat sources such as radiators, heat registers, stoves, or other products (including amplifiers) that produce heat.

## SERVICING

### 1. Servicing

If your product is not operating correctly or exhibits a marked change in performance and you are unable to restore normal operation by following the detailed procedure in its operating instructions, do not attempt to service it yourself as opening or removing covers may expose you to dangerous voltage or other hazards. Refer all servicing to qualified service personnel.

### 2. Damage Requiring Service

Unplug this product from the wall outlet and refer servicing to qualified service personnel under the following conditions:

- When the power supply cord or plug is damaged.
- If liquid has been spilled, or objects have fallen into the product.
- If the product has been exposed to rain or water.
- If the product does not operate normally by following the operating instructions. Adjust only those controls that are covered by the operating instructions as an improper adjustment of other controls may result in damage and will often require extensive work by a qualified technician to restore the product to its normal operation.
- If the product has been dropped or damaged in any way.
- When the product exhibits a distinct change in performance—this indicates a need for service.

### 3. Replacement Parts

When replacement parts are required, be sure the service technician has used replacement parts specified by the manufacturer or have the same characteristics as the original part. Unauthorized substitutions may result in fire, electric shock or other hazards.

### 4. Safety Check

Upon completion of any service or repairs to this product, ask the service technician to perform safety checks to determine that the product is in safe operating condition.

## SUPPLY POWER

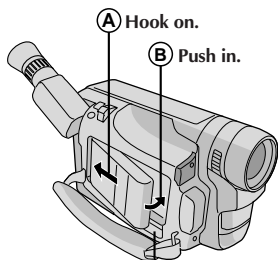

BATTERY RELEASE

### Using the battery pack

Hook its end to the camcorder (A) and push the battery pack in until it locks in place (B).  
(Charging procedure, pg. 8)

### To remove the battery pack

Slide BATTERY RELEASE and pull out the battery pack.

## INSERTING A VIDEO CASSETTE

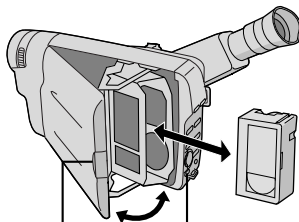

PUSH Button EJECT Switch

- 1 Slide EJECT to open the cassette holder.
- 2 Insert a video cassette.
- 3 Press PUSH to close the cassette holder.  
(For more details, pg. 13)

## PLAYBACK

### 2 REW (◀◀) Button

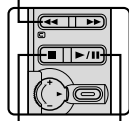

### 3 PLAY/PAUSE (▶/||) Button

STOP (■) Button

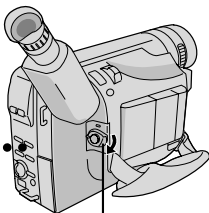

### 1 Set to "PLAY"

- 1 Set the Power Switch to "PLAY".
  - 2 Press REW (◀◀).  
— The tape will automatically stop at the beginning of the tape.
  - 3 Press PLAY/PAUSE (▶/||).  
— Playback starts and the playback picture appears.
- To stop playback, press STOP (■).  
(For more details, pg.36.)

Or simply play back the tape on a VHS VCR using the Cassette Adapter (VHS Playpak).  
 pg. 39

## SHOOTING

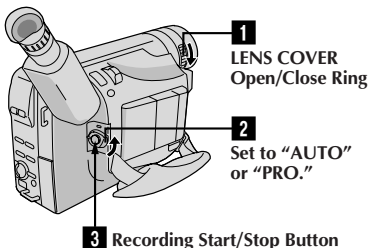

- 1 Turn the LENS COVER Open/Close Ring to open the lens cover.
  - 2 Set the Power Switch to "AUTO" or "PRO.". — The power lamp will light and an image will appear.
  - 3 Press the Recording Start/Stop Button.  
— Recording starts.
- To stop recording temporarily, momentarily press the Recording Start/Stop Button once again.  
(For more details, pgs. 16, 17)

## REMEMBER

**The Logical Choice**

Compact VHS  
VHS

*The only compact video cassettes that can be used with your VHS VCR\**

\*with VHS Playpak

**Program AE with Special Effects** (☞ pg. 22, 23)

- Electronic Fog Filter
- ND Effect
- Sepia
- Twilight
- Sports
- Nega/Posi
- 1/2000 sec. High Speed Shutter

**5-Sec. Recording** (☞ pg. 20)

**Menu Adjustment** (☞ pg. 26, 27, 28)

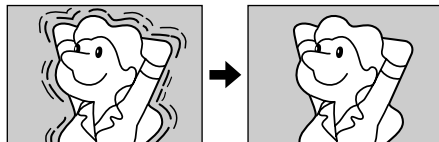
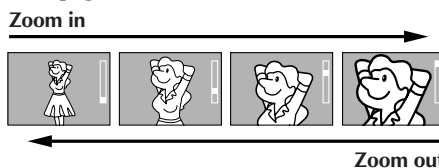
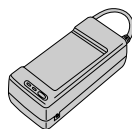
**Picture Stabilizer** (☞ pg. 20)

**Digital Hyper Zoom** (☞ pg. 18)

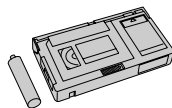
**PROVIDED ACCESSORIES**

- AC Power Adapter/  
Charger AA-V15U

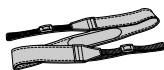

- Cassette Adapter  
(VHS Playpak) C-P7U



- Shoulder Strap

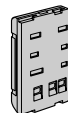

- Battery Pack  
BN-V11U



- Lithium Battery  
CR2025 x 1  
(for clock operation)

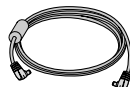

- DC Cord



<b>GETTING STARTED</b>	<b>8 – 15</b>
Power .....	8
Clock (Lithium) Battery Insertion/Removal .....	10
Date/Time Settings .....	11
Recording Mode Setting .....	12
Tape Length Setting .....	12
Loading/Unloading A Cassette .....	13
Grip Adjustment .....	14
Viewfinder Adjustment .....	14
Shoulder Strap Attachment .....	15
Tripod Mounting .....	15
<b>RECORDING</b>	<b>16 – 35</b>
Basic Recording .....	16
Basic Features .....	18
Advanced Features .....	21
<b>PLAYBACK</b>	<b>36 – 41</b>
Basic Playback .....	36
Features .....	37
Using The Cassette Adapter .....	39
Basic Connections And Tape Dubbing .....	40
<b>USER MAINTENANCE</b>	<b>42</b>
<b>TROUBLESHOOTING</b>	<b>43 – 44</b>
<b>INDEX</b>	<b>45 – 48</b>
Indications .....	45
Controls, Connectors And Indicators .....	46
Terms .....	48
<b>CAUTIONS</b>	<b>49 – 50</b>
<b>SPECIFICATIONS</b>	<b>51</b>
<b>OPTIONAL ACCESSORIES</b>	<b>51</b>
<b>ESPAÑOL</b>	<b>52 – 53</b>
<b>FOR SERVICING (Only in U.S.A.)</b>	<b>54</b>
<b>WARRANTY (Only in U.S.A.)</b>	<b>55</b>

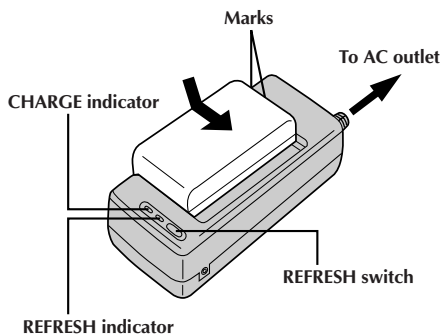

### REFRESH

The AC Power Adapter/Charger features a REFRESH function that allows you to fully discharge the battery pack before recharging.

Perform the REFRESH function after no less than 5 chargings.

#### To discharge the battery . . .

.... attach the battery pack to the adapter as shown in the above illustration. Then push REFRESH. The REFRESH indicator lights when discharging starts, and goes out when discharging is complete.

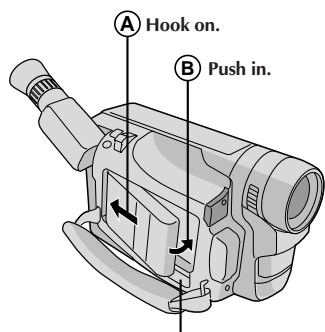

BATTERY RELEASE

### ATTENTION:

Before detaching the power source, make sure that the camcorder's power is turned off. Failure to do so can result in a camcorder malfunction.

## Power

This camcorder's 3-way power supply system lets you choose the most appropriate source of power.

### NOTES:

- No function is available without power supply.
- Use only the specified power supply.
- Do not use provided power supply units with other equipment.

## CHARGING THE BATTERY PACK

### 1 SUPPLY POWER

Connect the charger's AC power cord to a wall outlet.

### 2 ATTACH BATTERY PACK

Align the marks and slide the battery pack in the direction of the arrow until it locks in place.

- The CHARGE indicator begins blinking to indicate charging has started.

### 3 DETACH BATTERY PACK

When the CHARGE indicator stops blinking but stays lit, charging is finished. Slide the battery pack opposite the direction of the arrow.

Battery pack	Charging time	Discharging time
BN-V11U	approx. 1 hr. 10 min.	approx. 3 hrs. 30 min.
BN-V12U	approx. 1 hr. 10 min.	approx. 3 hrs. 30 min.
BN-V20U	approx. 1 hr. 50 min.	approx. 6 hrs. 40 min.

## USING THE BATTERY PACK

### 1 ATTACH BATTERY PACK

Hook its end to the camcorder (A) and push the battery pack in until it locks in place (B).

### 2 DETACH BATTERY PACK

Slide BATTERY RELEASE and pull out the battery pack.

Battery pack	Approximate recording time (unit: min.)
BN-V11U	70
BN-V12U	70
BN-V20U	110

## INFORMATION:

VU-V856KIT is a set composed of the BN-V856U battery pack and AA-V80U AC Power Adapter/Charger.

The BN-V856U battery pack provides approx. 7 hours of recording time. Also read thoroughly the VU-V856KIT's instruction manuals.

It is impossible to charge the BN-V856U battery pack using the provided AC Power Adapter/Charger. Use the optional AA-V80U AC Power Adapter/Charger.



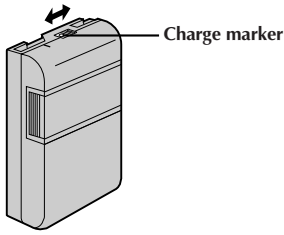

## Charge Marker

A charge marker is provided on the battery pack to help you remember whether it has been charged or not. Two colors are provided (red and black)—you choose which one means charged and which means discharged.

## NOTES:

- The recording time per charge is affected by such factors as the time spent in Record-Standby mode and the frequency of zooming. It is safer to have spare battery packs to cover 3 times the planned shooting time.
- Charging times noted on page 8 are for a fully discharged battery pack, and discharging times are for a fully charged battery pack.
- Charging and discharging times vary according to the ambient temperature and the status of the battery pack.
- Remember to set the charge marker after charging a battery pack or after detaching a discharged one from your camcorder.
- Perform the REFRESH function after no less than 5 chargings.
- While the AC Power Adapter/Charger's power cord is disconnected from the AC outlet, it is possible to discharge the battery by pressing the REFRESH switch. During that time, the AC Power Adapter/Charger does not charge the battery. When discharging is complete, detach the battery from the AC Power Adapter/Charger to store it.
- High temperatures can damage the battery pack, so use only where good ventilation is available. Do not allow it to discharge in a container, such as a bag.
- If you stop recharging or discharging part way through, make sure to remove the battery pack before unplugging the adapter's AC cord.
- Remove the battery pack from the adapter immediately after discharging.
- To avoid interference with reception, do not use the AC Power Adapter/Charger near a radio.
- Make sure you unplug the DC cord before charging or discharging the battery pack.
- The CHARGE indicator may not light properly with a brand new battery pack, or with one that has been stored for an extended period. In this case, remove and reattach the battery pack and recharge it. The CHARGE indicator should blink during recharging. If it doesn't, contact your nearest JVC dealer.

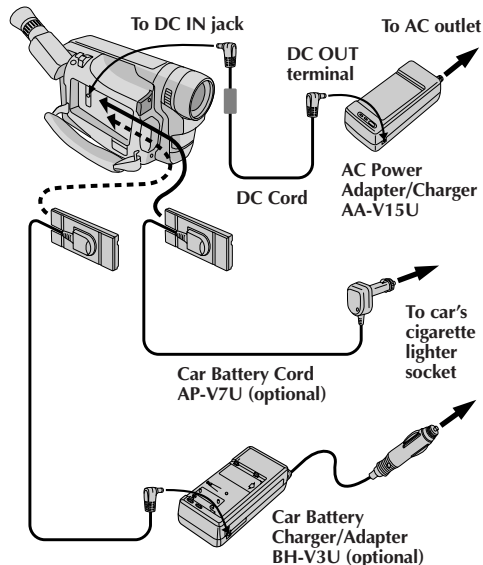

## USING AC POWER

Use the AC Power Adapter/Charger (connect as shown in the illustration to the left).

## NOTES:

- The provided AC Power Adapter/Charger features automatic voltage selection in the AC range from 110 V to 240 V.
- When using the DC cord, make sure you connect the end of the cord with the core filter to the camcorder. The core filter reduces interference.

## USING A CAR BATTERY

Use the optional Car Battery Cord or Car Battery Charger/Adapter (connect as shown in the illustration to the left).

## NOTES:

- When using the car battery, leave the engine idling.
- The optional Car Battery Charger (BH-V3U) can also be used to charge the battery pack (except BN-V20U/V856U).
- When using the optional Car Battery Charger or Car Battery Cord (AP-V7U), refer to the respective instruction booklet.

## Clock (Lithium) Battery Insertion/Removal

This battery is necessary for clock operation and to perform date/time settings.

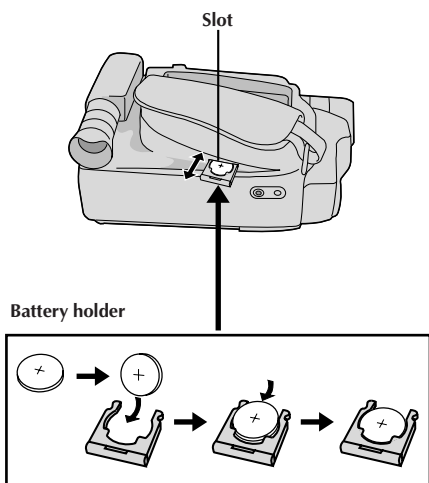

### 1 SWITCH OFF POWER

Switch off the unit's power and remove the power supply unit (battery pack, AC Power Adapter/Battery Charger, etc.).

### 2 REMOVE BATTERY HOLDER

Pull out the battery holder.

### 3 INSERT BATTERY IN HOLDER

Insert the battery in the holder, and be sure to have the "+" mark visible.

### 4 RE-INSERT HOLDER

Slide the holder back into the slot until you hear a click.

### NOTE:

See "SAFETY PRECAUTIONS" (☞ pg. 2) for information on safe handling of lithium batteries.

## Date/Time Settings

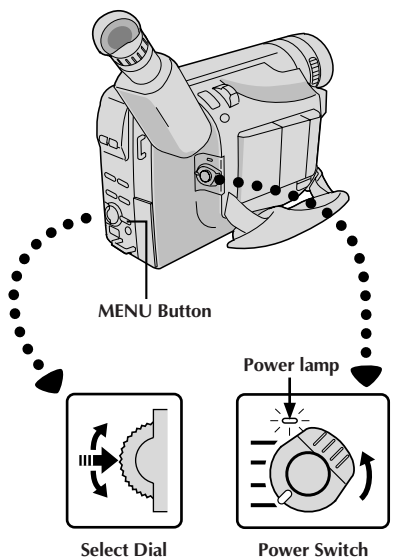

Display

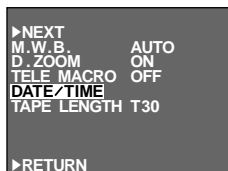

Menu Screen



DATE/TIME Menu

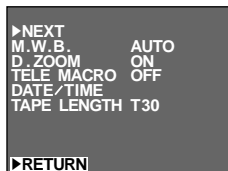

### 1 ACCESS MENU SCREEN

Set the Power Switch to "PRO.", then press MENU.

- The power lamp comes on.

### 2 SELECT FUNCTION

Rotate the Select Dial to move the highlight bar to "DATE/TIME", then press it. The DATE/TIME Menu appears.

- If you decide you want to return the date and time to the previous settings, rotate the Select Dial to move the highlight bar to "EXIT" and press it, then go to step 6.
- If you want to set only the time without changing the date, go to step 4.

### 3 SET DATE

Rotate the Select Dial to move the highlight bar to the item you want to set and then press it. When the setting begins blinking, rotate the Select Dial until the correct setting appears and then press it. The setting stops blinking.

- Repeat this procedure until you're satisfied with the Date settings ("YEAR", "MONTH" and "DAY").

### 4 SET TIME

Rotate the Select Dial to move the highlight bar to "TIME" and then press it. When the hour setting begins blinking, rotate the Select Dial until the correct setting appears and then press it. When the hour setting stops blinking and the minute setting begins blinking, rotate the Select Dial until the correct setting appears and then press it. The minute setting stops blinking.

### 5 START CLOCK OPERATION

When none of these settings ("YEAR", "MONTH", "DAY", "TIME") blinks, rotate the Select Dial to move the highlight bar to "EXIT", and press it. The Menu Screen reappears with the highlight bar on "RETURN".

### 6 CLOSE MENU SCREEN

Press the Select Dial.

## NOTE:

To display the date and time in the camcorder's display and on a connected TV, see "Date/Time Insert" (pg. 24).

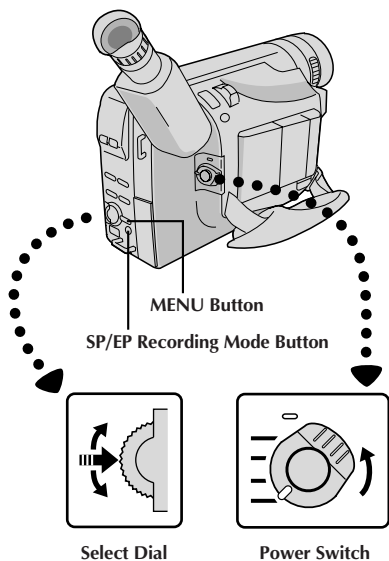

Viewfinder

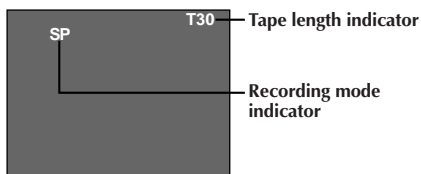

Display

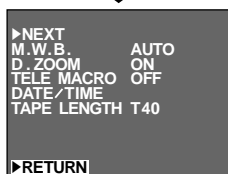
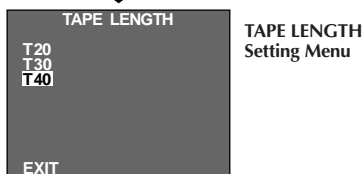
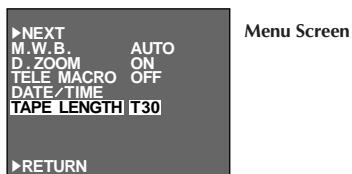

## Recording Mode Setting

Set depending on your preference.

### 1 SET RECORDING MODE

First set the Power Switch to "AUTO" or "PRO.". Press **SP/EP** for more than 1 second. "SP" (Standard Play) provides higher picture and sound quality and is better for dubbing, while "EP" (Extended Play) is more economical, providing three times the recording time.

### NOTE:

If the recording mode is switched during recording, the playback picture will be blurred at the switching point.

## Tape Length Setting

Set the tape length according to the length of the tape used.

### 1 ACCESS MENU SCREEN

First set the Power Switch to "PRO.". Press **MENU**.

### 2 SELECT FUNCTION

Rotate the Select Dial to move the highlight bar to "TAPE LENGTH", then press it. The TAPE LENGTH Setting Menu appears.

### 3 SET TAPE LENGTH

Rotate the Select Dial to move the highlight bar to the correct setting. T20=20 minutes of recording time, T30=30 minutes, and T40=40 minutes (in SP).

- If you decide you want to return the tape length to the previous setting, rotate the Select Dial to move the highlight bar to "EXIT".

### 4 CLOSE MENU SCREEN

Press the Select Dial. The Menu Screen reappears with the highlight bar on "RETURN". Press the Select Dial again to close the Menu Screen.

### NOTE:

The tape remaining time (⏮ pg. 17) displayed in the viewfinder is correct only if the correct tape length has been selected.

## Loading/Unloading A Cassette

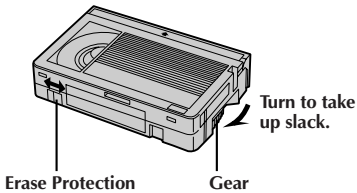
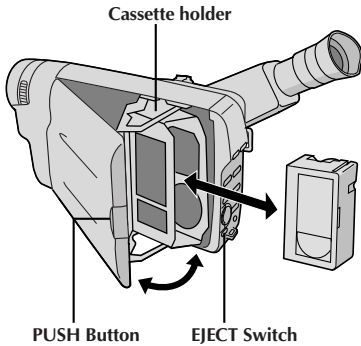

### 1 OPEN CASSETTE HOLDER

Slide **EJECT** until the holder opens. Do not use force to open.

### 2 INSERT/REMOVE CASSETTE

Make sure the label is facing outward.

### 3 CLOSE CASSETTE HOLDER

Press **PUSH** and make sure the holder is closed and locked.

### NOTES:

- The cassette holder cannot be opened unless a power supply is attached.
- Make sure that the tape is not slack when loading the cassette. If there is any slack, turn the gear on the cassette in the direction of the arrow to take up the slack.
- Make sure the Erase Protection tab is in the position that allows recording. If not, slide the tab. Some cassettes have removable tabs. If the tab has been removed, cover the hole with adhesive tape.
- The cassette holder cannot be opened while the camcorder is in the record mode.

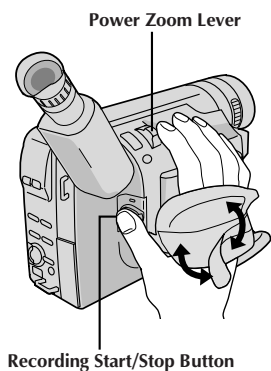

## Grip Adjustment

- 1 EXPAND LOOP**  
Separate the Velcro strip.
- 2 INSERT HAND**  
Pass your right hand through the loop and grasp the grip.
- 3 ADJUST STRAP LENGTH**  
Adjust so your thumb and fingers can easily operate the Recording Start/Stop Button and Power Zoom Lever. Refasten the Velcro strip.

## Viewfinder Adjustment

- 1 SELECT OPERATION MODE**  
Set the Power Switch to "CAMERA" ("AUTO" or "PRO.").
- 2 POSITION VIEWFINDER**  
Adjust the viewfinder manually for best viewability (see illustration at left).
- 3 ADJUST DIOPTR**  
Turn the Diopter Adjustment Control until the indications in the viewfinder are clearly focused.

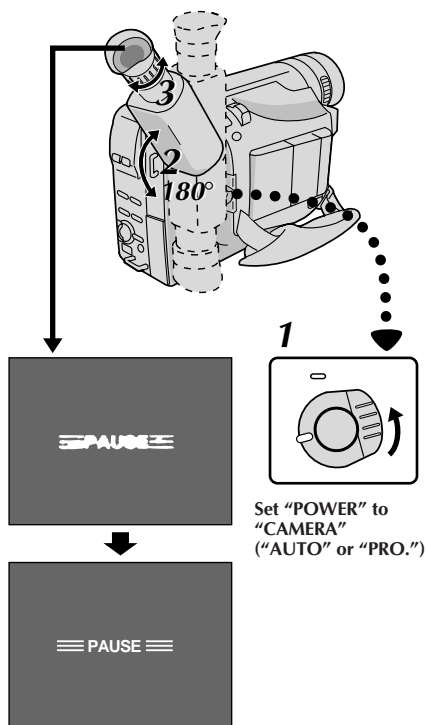

## Shoulder Strap Attachment

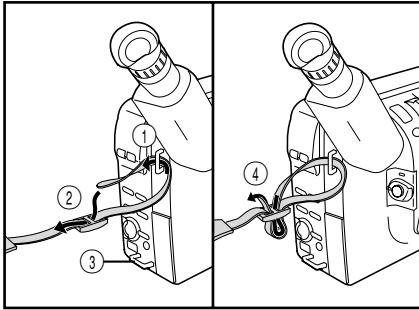

### 1 ATTACH STRAP

Following the illustration at left, thread the strap through the top of the eyelet (1), then fold it back and thread it through the buckle (2). Repeat the procedure to attach the other end of the strap to the other eyelet (3), making sure the strap is not twisted.

### 2 ADJUST LENGTH

Adjust as shown in the illustration at left (4).

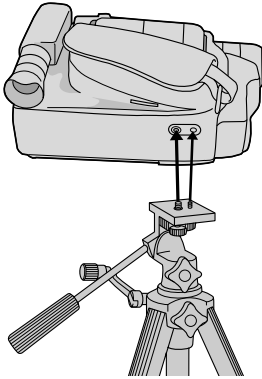

## Tripod Mounting

### 1 ALIGN AND TIGHTEN

Align the screw and camera direction stud on the tripod with the camera's mounting socket and stud hole. Then tighten the screw.

### CAUTION:

When using a tripod, be sure to open and extend its legs fully to stabilize the camcorder. To prevent damage to the unit caused by falling over, do not use a small-sized tripod.

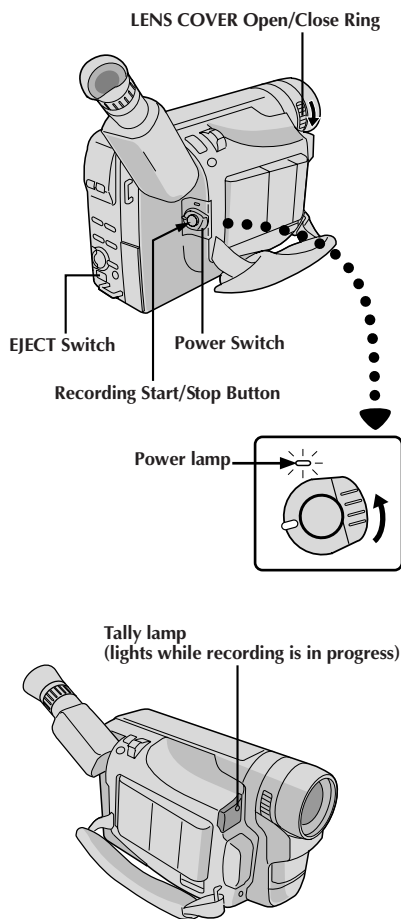
**NOTE:**

You should already have performed the procedures listed below. If not, do so before continuing.

- Power (☞ pg. 8)
- Recording Mode Setting (☞ pg. 12)
- Tape Length Setting (☞ pg. 12)
- Grip Adjustment (☞ pg. 14)
- Viewfinder Adjustment (☞ pg. 14)

**1 LOAD A CASSETTE**

Slide **EJECT** to open the cassette holder, then insert the cassette with the label facing out. Press **PUSH** to ensure the holder is closed and locked.

**2 ENTER RECORD-STANDBY MODE**

Turn the **LENS COVER Open/Close Ring** to open the lens cover, then set the Power Switch to "CAMERA" ("AUTO" or "PRO.").

- The power lamp lights and the camcorder enters the Record-Standby mode.
- The scene you are aimed at appears on the viewfinder screen, with the word "PAUSE" superimposed upon it.

**3 START SHOOTING**

Press the Recording Start/Stop Button.

- "REC" appears in the viewfinder while recording is in progress.

**Power Switch Position**

According to the Power Switch position you have selected, the following functions are available:

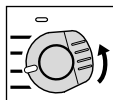

**AUTO**  
(Full Auto mode):

Allows you to record using NO special effects or manual adjustments. Suitable for standard recording.

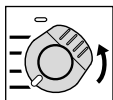

**PRO.**  
(PRO. mode):

Allows you to set various recording functions using the menus. If you want more creative capabilities than full auto recording, try this mode.

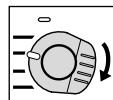

**OFF:**

Allows you to switch off the camcorder.



## Tape remaining time indicator

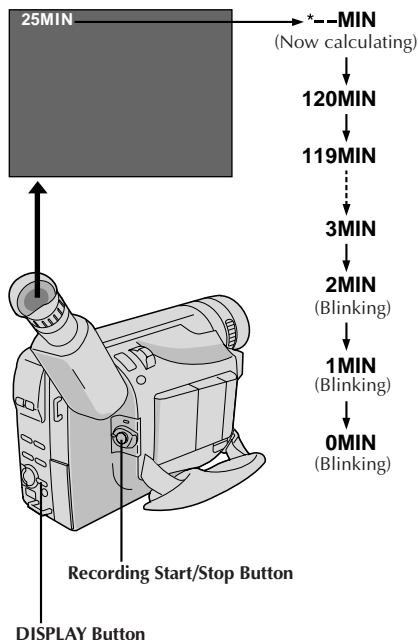

## 4 STOP RECORDING

Press the Recording Start/Stop Button again to stop recording.

- The camcorder re-enters the Record-Standby mode.

### NOTES:

- The cassette holder cannot be opened unless a power supply is attached.
- There may be a delay after you slide **EJECT** until the holder opens. Do not use force.
- The tape remaining time is only displayed in the viewfinder as shown.
- The remaining time indicated in the viewfinder is approximate.
- The time required to calculate the remaining tape length, and the accuracy of the calculation, may vary according to the type of tape used.
- The tape remaining time indicator is correct only if the correct tape length has been selected (☞ pg. 12).
- "TAPE END" appears when the tape reaches its end, and the power goes off automatically if left in this condition for 5 minutes. "TAPE END" also appears when a cassette whose tape is already at its end is loaded.
- If the Record-Standby mode continues for 5 minutes without performing Zoom or any other operations, the camcorder's power shuts off automatically. Set the Power Switch to "POWER OFF", and then back to "CAMERA" to turn the camcorder on again.
- If the Recording Start/Stop button is pressed after the Record-Standby mode has continued for over 5 minutes, recording may not start immediately.
- If you are recording on a cassette from the middle (such as when a tape is removed and re-inserted during recording), use the Retake function (☞ pg. 19) to find the end of the last recording so you don't erase any of it.
- The LENS COVER warning blinks for about 5 seconds when the camcorder is turned on with the cover closed.
- While shooting, sound is not heard from the speaker.
- To turn the tally lamp off during recording, refer to pgs. 26 and 28.

## Viewfinder Indications

By pressing **DISPLAY**, you can make the following, indications appear/disappear from the camcorder's display: cassette warning, tape remaining time, battery pack remaining power indicator and tape length indicator (☞ pg. 45).

### 1 PRESS DISPLAY BUTTON

When you do not want the indications to appear, press **DISPLAY** for longer than approximately 1 second. Certain indications disappear.

Press again for longer than approx. 1 second to make the indications reappear.

### NOTE:

Even if **DISPLAY** is pressed, the tape remaining time appears blinking when the tape is about to reach its end, and the battery pack remaining power indicator also appears blinking when the power is almost gone.

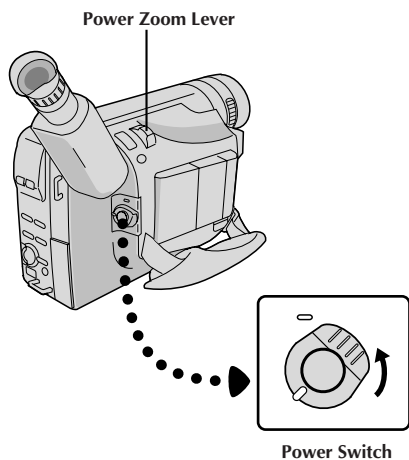
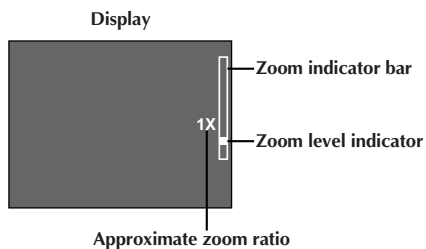
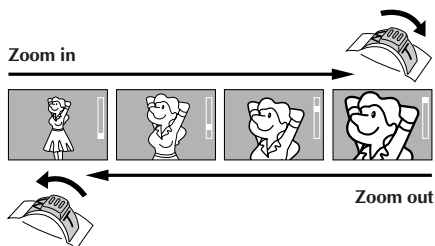

## FEATURE: Zooming

### PURPOSE:

To produce the zoom in/out effect, or an instantaneous change in image magnification.

Digital circuitry extends the maximum magnification offered by optical zoom. This system is called Digital Zoom.

### OPERATION:

#### Zoom In

Push the Power Zoom Lever towards "T".

#### Zoom Out

Push the Power Zoom Lever towards "W".

- The quicker you push the Power Zoom Lever, the quicker the zoom action.

### NOTES:

- Focusing may become unstable during Zooming. In this case, set the zoom while in Record-Standby, lock the focus by using the manual focus (☞ pg. 31), then zoom in or out in Record mode.
- The zoom level indicator (■) moves during zoom. Once the zoom level indicator reaches the top of the zoom indicator bar, all magnification from that point is through digital processing.
- When using Digital Zoom, the image quality of the image may suffer. To deactivate Digital Zoom, set "D.ZOOM" to "OFF" in the Menu Screen (☞ pg. 27).

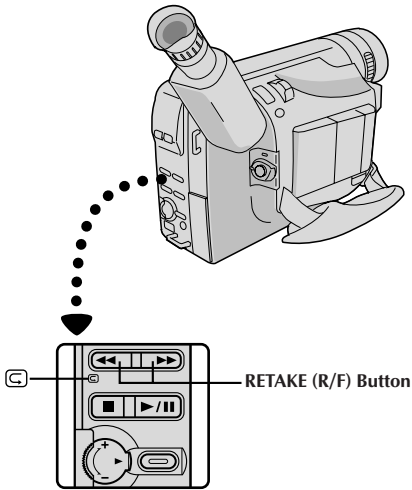

### FEATURE: Quick Review

#### PURPOSE:

To check the end of the last recording.

#### OPERATION:

- 1) Press "□" and release quickly during the Record–Standby mode.
- Tape is rewound for about 2 seconds and played back automatically, then pauses in Record–Standby mode for the next shot.

#### NOTE:

*Distortion may occur at the start of playback. This is normal.*

### FEATURE: Retake

#### PURPOSE:

To re-record certain segments.

#### OPERATION:

- 1) Make sure the camcorder is in the Record–Standby mode.
- 2) Press either **RETAKE** to reach the start point for new recording. Pressing "F" forwards the tape and pressing "R" reverses it.
- 3) Press the Recording Start/Stop Button to start recording.

#### NOTE:

*Noise bars appear and pictures may become monochrome or darken during Retake. This is normal.*

5 SEC. REC Button

P. STABILIZER Button

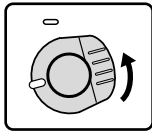
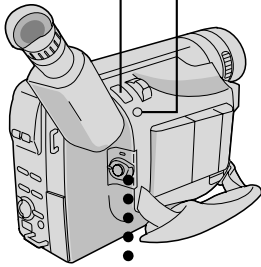

Power Switch

Display

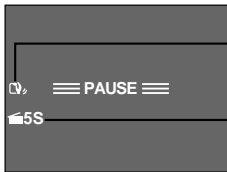

Picture stabilizer indicator

5 Sec. Rec mode indicator

**FEATURE: Picture Stabilizer****PURPOSE:**

To compensate for unstable images caused by camera-shake, particularly at high magnification.

**OPERATION:**

1) Press **P. STABILIZER**. "📷," appears.

■ To switch off the Picture Stabilizer, press

**P. STABILIZER**. The indicator disappears.

**NOTES:**

- Accurate stabilization may not be possible if hand shake is excessive, or under the following conditions:
  - When shooting subjects with vertical or horizontal stripes.
  - When shooting dark or dim subjects.
  - When shooting subjects with excessive backlighting.
  - When shooting scenes with movement in various directions.
  - When shooting scenes with low-contrast backgrounds.
- Switch off the Picture Stabilizer when recording with the camcorder on a tripod.
- The "📷" indicator appears blinking if the Stabilizer cannot be used.

**FEATURE: 5Sec. Rec (5-sec. Recording)****PURPOSE:**

To record a scene for 5 seconds, providing quick scene transitions like those seen in TV programs.

**OPERATION:**

■ Make sure the recording mode is set to "SP".

1) During Record-Standby, press **5SEC. REC.** "📷 5S" appears and 5Sec. Rec is reserved.

2) Press the Recording Start/Stop Button. Recording starts, and after 5-second recording is finished, the camcorder reenters the Record-Standby mode automatically.

■ To cancel the 5Sec. Rec. function, press **5SEC. REC** again so that "📷 5S" disappears.

**NOTE:**

Fade/Wipe (📷 pg. 21) cannot be activated by pressing **5SEC. REC.**

[Ex.: Fader]

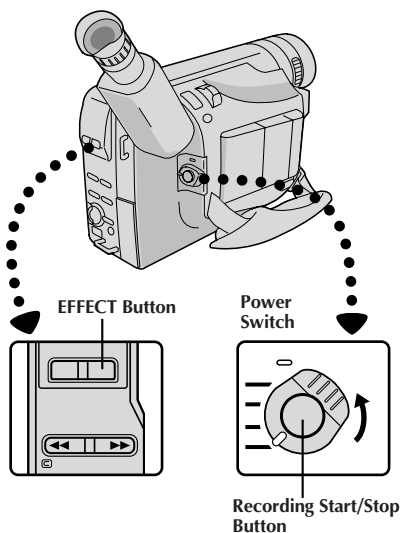
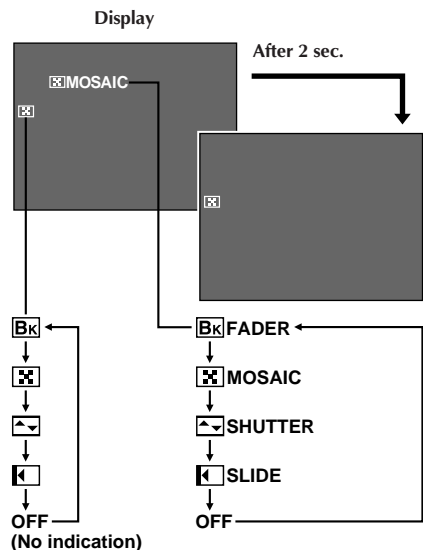
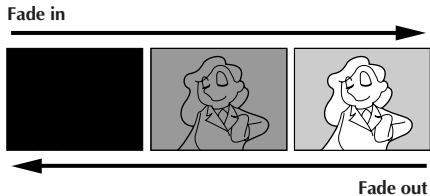

## Fade/Wipe

These effects let you make pro-style scene transitions. Fade- or wipe-in works at recording start, and fade- or wipe-out works at recording end or when you enter Record-Standby mode.

- 1 SELECT OPERATION MODE**  
Set the Power Switch to "PRO."
- 2 ENGAGE FADE- OR WIPE-STANDBY MODE**  
Press **EFFECT** to cycle through the modes as shown at left. Once the desired mode appears, it is selected and reserved.
  - The selected mode's name and its indication are displayed for approx. 2 seconds. Then the name disappears, and only the indication remains.
- 3 START OR END RECORDING**  
Press the Recording Start/Stop Button to activate fade-in/out or wipe-in/out.
- 4 TO CANCEL FADE- OR WIPE-STANDBY MODE**  
Press **EFFECT** repeatedly until "OFF" appears.
  - "OFF" is displayed for approx. 2 seconds and the fade/wipe standby mode is canceled.

RECORDING

### **Bk** FADER

Fades in/out to a black screen.

### **☒** MOSAIC (Fader)

Gradually turns/returns the picture into/from a mosaic pattern.

### **⬆** SHUTTER (Wipe)

A black screen moves in from the top and bottom, closing over the image like a shutter, or a new image pushes open the black screen vertically from the center.

### **⬅** SLIDE (Wipe)

A black screen moves in from the left to gradually cover the image, or a new image moves in from right to left.

## NOTES:

- Pressing and holding the Recording Start/Stop Button allows you to vary the length for the image during fade in/out or wipe in/out.
- The screen becomes slightly reddish when the Fade/Wipe is used with Sepia (☞ pg. 23).
- With the Electronic fog filter mode (☞ pg. 23) engaged, the image fades in/out to a white screen.

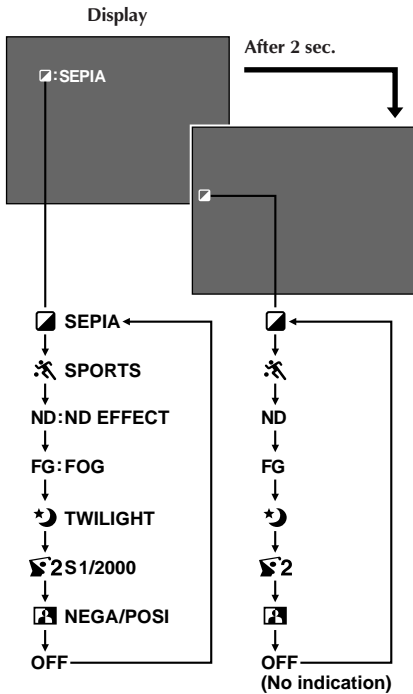

## Program AE With Special Effects

All you have to do to access any of the variety of shooting effects is press **P.AE**.

### 1 SELECT OPERATION MODE

Set the Power Switch to "PRO."

### 2 SELECT MODE

Press **P.AE** to cycle through the modes as shown on the left.

- The selected mode's name and its indication are displayed for approx. 2 seconds. Then the name disappears, and only the indication remains. The mode is activated.

### NOTES:

- Only one mode can be engaged at a time.
- The screen becomes slightly reddish when the Fade/Wipe (pg. 21) is used in the Sepia mode.
- The screen becomes slightly dark in the High Speed Shutter mode. Use in well-lit situations.
- In the "High Speed Shutter" or "Sports" modes, picture color may be adversely affected if the subject is lit by alternating discharge-type light sources such as fluorescent or mercury-vapor lights.

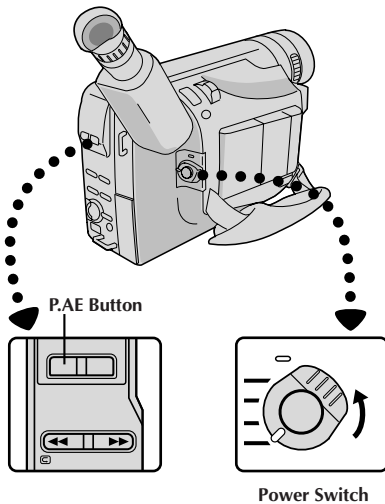

Display

Mode

**Sepia**

The scene being shot is recorded in sepia-tinted (reddish-brown) monochrome, giving the effect of an older movie. Use together with Wide (📖 pg. 27) for the authentic look of a classic Hollywood movie.

**Sports**

High shutter speed clearly captures fast-moving action.

**ND Effect**

A black mist darkens the picture, as when an ND filter is used. Helps to counter the effects of glare on the subject.

**Electronic Fog Filter**

Makes the picture look misty white, as when an external fog filter is attached to the lens. Softens the image and gives it a “fantasy” look.

**Twilight**

Dusk, twilight scenery, fireworks, etc., look more natural and dramatic. The following happens when Twilight mode is selected:

- Auto gain control is turned off.
- White Balance is set to “☀️” (FINE day mode), but can also be manually changed to another mode (📖 pg. 32).
- Auto Focus becomes available only in the range of 10 m (33 ft.) to infinity. To focus when the subject-to-camera distance is less than 10 m (33 ft.), use manual focusing (📖 pg. 31).

Display

Mode

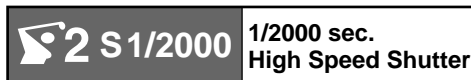
**High-Speed Shutter (1/2000s.)**

Captures faster action than Sports mode.

**Nega/Posi (Negative/Positive)**

The colors of a picture are reversed.

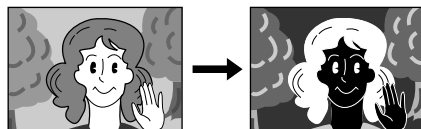

NEGA POSI mode

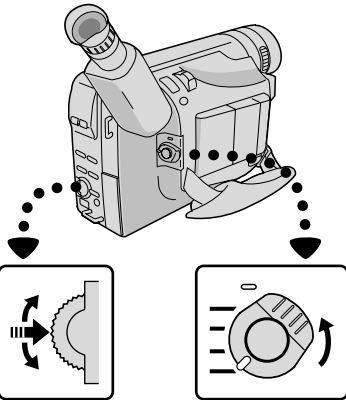

Select Dial

Power Switch

Display

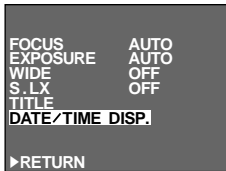

Menu Screen

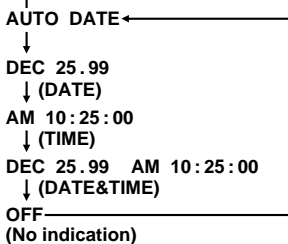
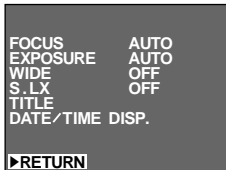
DATE/TIME DISP.  
Menu

## Date/Time Insert

This feature allows you to display the date and time in the viewfinder or on a connected color monitor, as well as to record them manually or automatically.

### 1 SELECT OPERATION MODE

Set the Power Switch to "PRO."

### 2 ACCESS MENU SCREEN

Press the Select Dial to display the Menu Screen.

### 3 ACCESS "DATE/TIME DISP." MENU

Move the highlight bar to "DATE/TIME DISP." by rotating the Select Dial while in Record-Standby. Then press it to display the DATE/TIME DISP. Menu.

### 4 SELECT THE DESIRED MODE

Move the highlight bar to the desired mode by rotating the Select Dial, then press it. The desired mode is activated.

- You should have already performed the Date/Time Setting procedure (pg. 11). If you haven't, do so first.

### 5 CLOSE MENU SCREEN

The Menu Screen reappears with the highlight bar on "RETURN". Then press the Select Dial to close the Menu Screen.

## NOTES:

### DISPLAY

- The selected display can be recorded.
- If you do not want to record the display, select the OFF mode before shooting.

### AUTO DATE

- Your camcorder automatically records the date for about 5 seconds after recording is initiated in the following situations:
  - After changing the date.
  - After loading a cassette.
  - After Auto Date Record mode is selected by rotating the Select Dial.
- In this mode, the date is replaced after 5 seconds with "AUTO DATE" but this is not recorded.



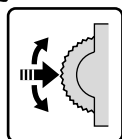
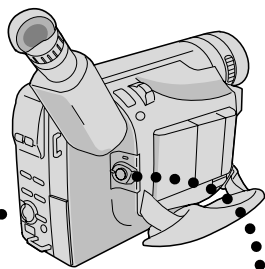

Select Dial

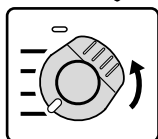

Power Switch

Display

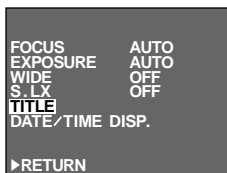

Menu Screen



TITLE Menu

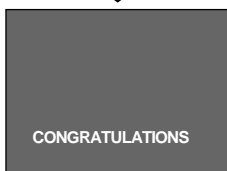
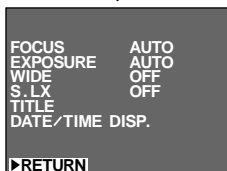

## Instant Titles

The camcorder has eight preset titles in memory. You can superimpose one of them above a previously stored title as shown in the illustration to the left.

Instant Titles can be displayed not only in English but also in French, Spanish and Portuguese. Change the setting in TITLE LANG. in the Menu Screen. (▶ pg. 26, 28).

- 1 SELECT OPERATION MODE**  
Set the Power Switch to "PRO."
- 2 ACCESS MENU SCREEN**  
Press the Select Dial to display the Menu Screen.
- 3 ACCESS "TITLE" MENU**  
Move the highlight bar to "TITLE" by rotating the Select Dial while in Record-Standby. Then press it to display the TITLE Menu.
- 4 SELECT THE DESIRED MODE**  
Move the highlight bar to the desired mode by rotating the Select Dial, then press it. The desired mode is activated.
  - If you wish to make the title indication disappear, select "OFF".
- 5 CLOSE MENU SCREEN**  
The Menu Screen reappears with the highlight bar on "RETURN". Then press the Select Dial to close the Menu Screen.

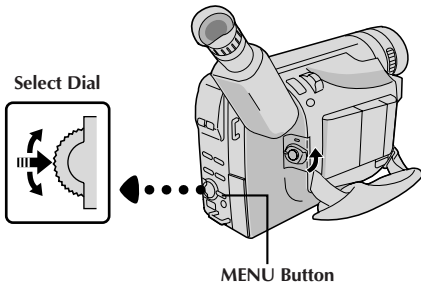

Display  
(ex. Menu Screen available  
using the MENU Button)

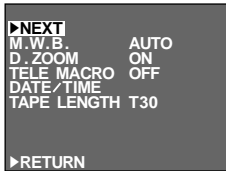

Menu Screen 1

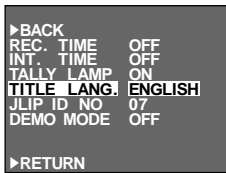

Menu Screen 2

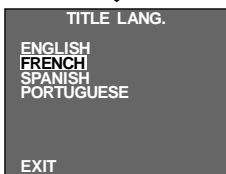
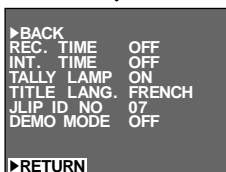
Setting Menu  
(ex. TITLE LANG.)

Normal Screen



## Using Menu For Detailed Adjustment

This camcorder is equipped with an easy-to-use, on-screen menu system that simplifies many of the more detailed camcorder settings.

### 1 SELECT OPERATION MODE

Turn the Power Switch to "PRO".

### 2 ACCESS MENU SCREEN

Menu access depends on the function you select.

**If you select the functions from the "Menu Screen Available Using The Select Dial" described on pg. 27 . . .**

.... press the Select Dial. The Menu Screen appears.

**If you select the functions from the "Menu Screen Available Using The MENU Button" described on pg. 27 and 28 . . .**

.... press MENU. The Menu Screen appears.

### 3 SELECT FUNCTION

Rotate the Select Dial to place the highlight bar on the desired function.

- To go from Menu Screen 1 to Menu Screen 2, rotate the Select Dial to "NEXT" and press it. To go back to Menu Screen 1 from Menu Screen 2, rotate the Select Dial to "BACK", and press it.
- If the setting you want cannot be found in the Menu Screen, place the highlight bar on "RETURN", then go to step 6.

### 4 MAKE SETTING

Press the Select Dial. The setting procedure depends on the function you select.

**If you select "FOCUS", "EXPOSURE", "TITLE", "DATE/TIME DISP." or "DATE/TIME" . . .**

.... see respective pages (FOCUS: pg. 30, 31, EXPOSURE: pg. 29, TITLE: pg. 25, DATE/TIME DISP.: pg. 24, DATE/TIME: pg. 11).

**If you select "WIDE", "D.ZOOM", "TELE MACRO" or "DEMO MODE" . . .**

.... the selected function's parameter starts blinking. Rotate the Select Dial until the desired parameter appears. Go to step 5.

**If you select "JLIPI ID NO." . . .**

.... press the Select Dial so that the number blinks, then rotate it until the desired number appears, and press it. Then rotate the Select Dial to move the highlight bar to "EXIT".

**If you select any other functions . . .**

.... rotate the Select Dial to move the highlight bar to the desired setting.

- If you decide you want to return to the previous setting, rotate the Select Dial to move the highlight bar to "EXIT".

### 5 END SETTING

Press the Select Dial. The Menu Screen reappears with the highlight bar on "RETURN".

### 6 CLOSE MENU SCREEN

Press the Select Dial. The normal screen reappears.

## NOTE:

No menu functions except "FOCUS" and "EXPOSURE" are available while in the Record mode.

## MENU SCREEN EXPLANATIONS

### Menu Screen Available Using The Select Dial

FOCUS	AUTO	Adjusts focus automatically.
	MANU	Allows you to adjust focus manually (☞ pg. 30, 31).
EXPOSURE	AUTO	Adjusts exposure automatically.
	MANU	Allows you to adjust exposure manually (☞ pg. 29).
WIDE	OFF	Does not display black bars.
	ON	Allows you to record black bars at the top and bottom of the screen to produce a cinema-like “wide-screen” effect.
S.LX	MAX	To record a subject in a darkly lit environment, when it is more convenient to shoot the subject with a brighter image even if the picture becomes slightly coarse.
	NORMAL	To record a subject in a dimly lit environment, when it is more convenient to shoot with a less coarse picture although the subject becomes slightly dark. This setting is suitable for measuring sensitivity conforming to EIA-639 (EIA* Standard for Low Light Sensitivity Measurement). *EIA : Electronic Industries Alliance
	OFF	Allows you to shoot dark scenes with no picture brightness adjustment.
TITLE	Allows you to superimpose one of eight preset titles (☞ pg. 25).	
DATE/TIME DISP.	Makes the date/time settings appear in the camcorder or on a connected monitor (☞ pg. 24).	

### Menu Screen Available Using The MENU Button

This Menu Screen cannot be accessed while recording.

M.W.B.	AUTO	<p>This camcorder's Automatic Color Temperature system senses the color temperature of the ambient lighting for automatic white balance adjustment. However, precise color adjustment is not possible under the following conditions:</p> <ul style="list-style-type: none"> <li>• When an object is in various shades of the same color.</li> <li>• When a predominantly red or brown object is being shot outdoors.</li> </ul> <p>In these cases, use the camcorder's built-in preset filters for white balance adjustment (☞ pg. 32, 33).</p>
	☀ : FINE	
	☁ : CLOUD	
	☀ : HALOGEN	
	MWB	
D. ZOOM	ON	Allows you to use the Digital Zoom. By digitally processing and magnifying images, zooming is possible from 16 times (the optical zoom limit), to a maximum of 50 times digital magnification.
	OFF	Digital Zoom is not available. Only optical zoom (maximum 16x magnification) can function. When set to “OFF” during Digital Zoom, zoom magnification changes to 16x.
TELE MACRO	OFF	<p>Usually the distance to a subject where the lens is in focus depends on the zoom magnification. Unless there is a distance of more than 1m (3.3 ft.) to the subject, the lens is out of focus at the maximum telephoto setting. When set to “ON”, you can shoot a subject as large as possible at a distance of approx. 60 cm (2 ft.).</p> <ul style="list-style-type: none"> <li>• Depending on the zoom position, the lens may go out of focus.</li> </ul>
	ON	

## Menu Screen Available Using The MENU Button (cont.)

<b>DATE/TIME</b>	Allows you to set the current date and time (☞ pg. 11).	
<b>TAPE LENGTH</b>	Allows you to set the tape length depending on the tape used (☞ pg. 12).	
<b>REC TIME</b>	This feature allows you to set the parameters for Animation and Time-Lapse recording (☞ pg. 35).	
<b>INT. TIME</b>	This feature allows you to set the parameters for Self-Timer (☞ pg. 34) and Time-Lapse recording (☞ pg. 34, 35).	
<b>TALLY LAMP</b>	<b>OFF</b>	The tally lamp remains off at all times.
	<b>ON</b>	The tally lamp comes on to signal the start of recording.
<b>TITLE LANG.</b>	Allows you to select the language (ENGLISH, FRENCH, SPANISH or PORTUGUESE) of Instant Titles (☞ pg. 25).	
<b>JLIP ID NO.</b>	This number is necessary when connecting the camcorder to a device such as a computer using the J terminal (JLIP). The numbers range from 01 to 99. Factory setting is 07.	
<b>DEMO MODE</b>	<b>OFF</b>	Automatic demonstration will not take place.
	<b>ON</b>	<p>Demonstrates certain functions such as Fade/Wipe, etc. When "DEMO MODE" is set to "ON" and the Menu Screen is closed, the demonstration starts.</p> <p><b>NOTES:</b></p> <ul style="list-style-type: none"> <li>● When a tape whose Erase Protection tab is in the position that allows recording is loaded in the camcorder, demonstration is not available.</li> <li>● By turning off the camcorder or inserting a tape whose Erase Protection tab is in the position that allows recording into it, "DEMO MODE" is set to "OFF" automatically.</li> <li>● During the demonstration, all functions except zoom are disabled.</li> </ul>

 : Factory-preset

## Exposure Control

This feature automatically adjusts the iris for the best available picture quality, but you can override and make the adjustment manually.

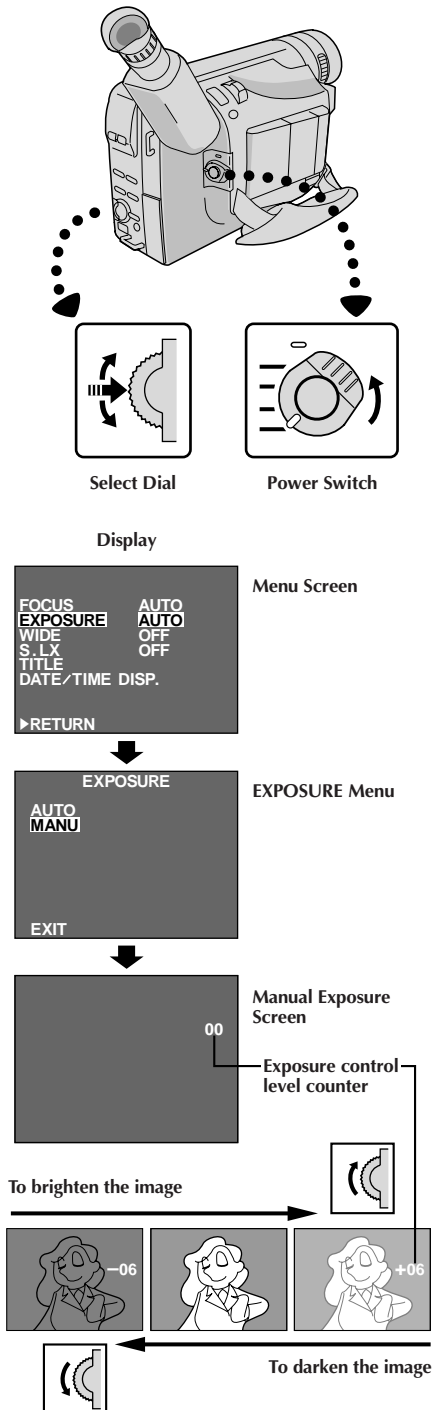

### 1 SELECT OPERATION MODE

Set the Power Switch to "PRO."

### 2 ACCESS MENU SCREEN

Press the Select Dial to display the Menu Screen.

### 3 ACCESS "EXPOSURE" MENU

Rotate the Select Dial to move the highlight bar to "EXPOSURE" and press it.

### 4 ACCESS MANUAL EXPOSURE

Rotate the Select Dial to move the highlight bar to "MANU", then press it. "00" (exposure control level counter) appears.

### 5 ADJUST EXPOSURE

*To brighten the image . . .*

.... rotate the Select Dial upward. The exposure control level counter increases (maximum +06).  
Go to step 6.

*To darken the image . . .*

.... rotate the Select Dial downward. The exposure control level counter decreases (maximum -06).  
Go to step 6.

### 6 END ADJUSTMENT OF EXPOSURE

Press the Select Dial. The Menu Screen reappears with the highlight bar on "RETURN".

### 7 CLOSE MENU SCREEN

Press the Select Dial. The Menu Screen disappears and the exposure control level counter reappears to indicate the exposure is adjusted.

### NOTES:

- To return to the factory setting, select "AUTO" in step 4.
- To re-adjust exposure, repeat the procedure from step 2.

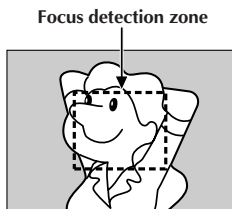

## Focusing

### AUTO FOCUS

The camcorder's Full Range AF system offers continuous shooting ability from close-up to infinity. However, correct focus may not be obtainable in the situations listed below (in these cases use manual focusing):

- When two subjects overlap in the same scene.
- When illumination is low.\*
- When the subject has no contrast (difference in brightness and darkness), such as a flat, one-color wall, or a clear, blue sky.\*
- When a dark object is barely visible in the viewfinder.\*
- When the scene contains minute patterns or identical patterns that are regularly repeated.
- When the scene is affected by sunbeams or light reflecting off the surface of a body of water.
- When shooting a scene with a high-contrast background.

\* The low-contrast warning "▲▲" appears.

### NOTES:

- If the lens is smeared or blurred, accurate focusing is not possible. Keep the lens clean, wiping with a piece of soft cloth if it gets dirty. When condensation occurs, wipe with a soft cloth or wait for it to dry naturally.
- When shooting a subject close to the lens, zoom out first (☞ pg. 18). If zoomed in in the auto focus mode, the camcorder could automatically zoom out depending on the distance between the camcorder and the subject. When Tele Macro (☞ pg. 27) is activated, the camcorder will not zoom out automatically.

## MANUAL FOCUS

**NOTE:**

You should already have made the necessary viewfinder adjustments ( pg. 14). If you haven't, do so before continuing.

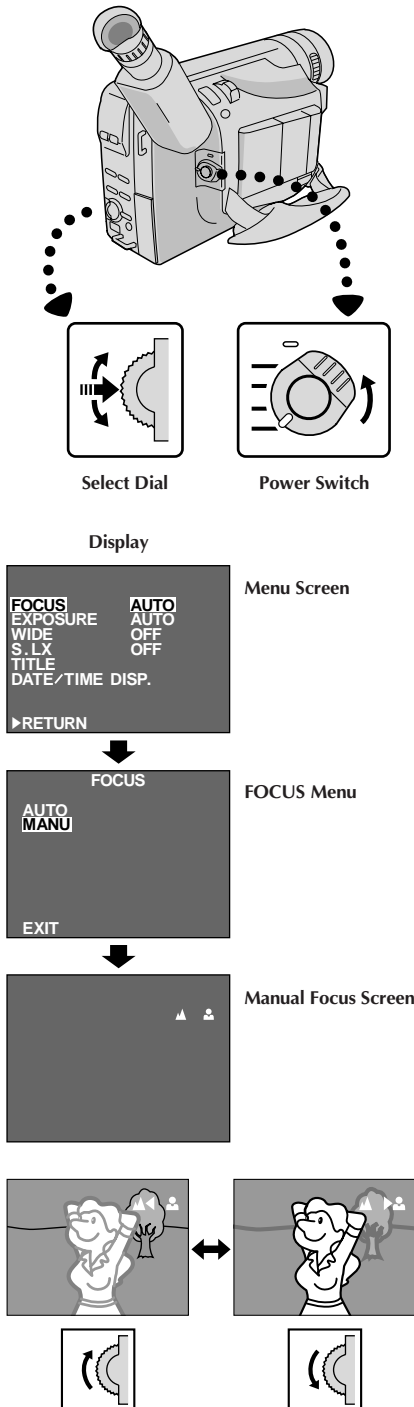
**1 SELECT OPERATION MODE**

Set the Power Switch to "PRO."

**2 ACCESS MENU SCREEN**

Press the Select Dial to display the Menu Screen.

**3 ACCESS "FOCUS" MENU**

Press the Select Dial.

**4 ACCESS MANUAL FOCUS**

Rotate the Select Dial to move the highlight bar to "MANU", then press it. "▲" and "●" appear. The focus is locked at this point.

**5 ADJUST FOCUS**

*To farther subject . . .*

... rotate the Select Dial upward. "◀" appears and blinks.

Go to step 6.

*To nearer subject . . .*

... rotate the Select Dial downward. "▶" appears and blinks.

Go to step 6.

**6 END ADJUSTMENT OF FOCUS**

Press the Select Dial. The Menu Screen reappears with the highlight bar on "RETURN".

**7 CLOSE MENU SCREEN**

Press the Select Dial. The Menu Screen disappears and "▲●" reappears to indicate the focus is locked.

**NOTES:**

- To return to Auto Focus, select "AUTO" in step 4.
- To re-adjust Manual Focus, repeat the procedure from step 2.
- Be sure to focus the lens in the maximum telephoto position when you use the Manual Focus mode. If you focus in on a certain subject in the wide-angle position, sharply focused images cannot be obtained when zoomed in because the depth-of-field is reduced at longer focal lengths.
- When the focus level cannot be adjusted any farther or closer, "▲" or "●" will blink.

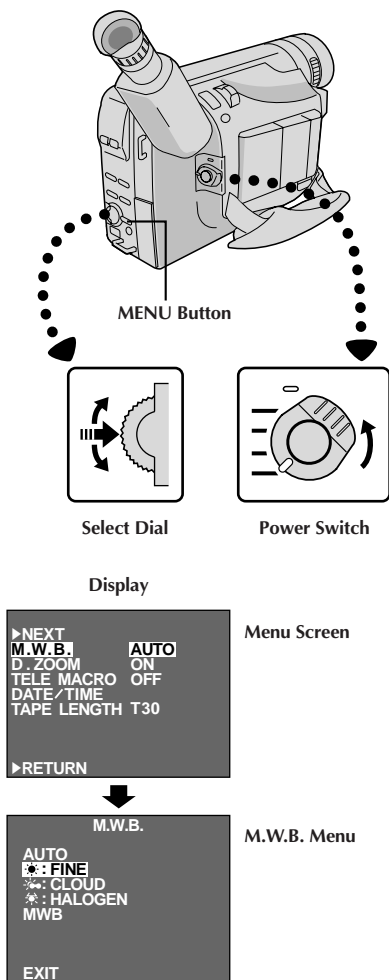

## White Balance Adjustment

A term that refers to the correctness of color reproduction under various lighting. If the white balance is correct, all other colors will be accurately reproduced. The white balance is usually adjusted automatically. However, the more advanced camcorder operator would prefer to control this function manually and achieve a more professional color/tint reproduction.

### 1 SELECT OPERATION MODE

Set the Power Switch to "PRO".

### 2 ACCESS MENU SCREEN

Press MENU. The Menu Screen appears.

### 3 ACCESS WHITE BALANCE ADJUSTMENT

Move the highlight bar to "M.W.B." by rotating the Select Dial, then press it. The Menu Screen disappears and the M.W.B. Menu appears.

### 4 SET FUNCTION PARAMETERS

Move the highlight bar to the required white balance by rotating the Select Dial.

#### "AUTO"

The white balance is adjusted automatically. This is the factory preset position.

#### "☀️" : FINE

When shooting outdoors on a sunny day.

#### "☁️" : CLOUD

When shooting outdoors on a cloudy day.

#### "💡" : HALOGEN

When using a video light or other similar type of lighting.

#### "MWB"

When shooting with the white balance already having been set on the subject (☞ pg. 35).

### 5 CLOSE MENU SCREEN

Press the Select Dial.

The Menu Screen reappears with the highlight bar on "RETURN". Press the Select Dial again to close the Menu Screen.

#### To Return To Automatic White Balance . . .

... select "AUTO" in step 4. Or set the Power Switch to "AUTO".

## NOTE:

White balance cannot be used when Sepia (☞ pg. 23) is activated.



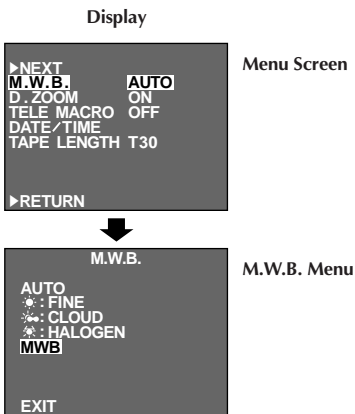
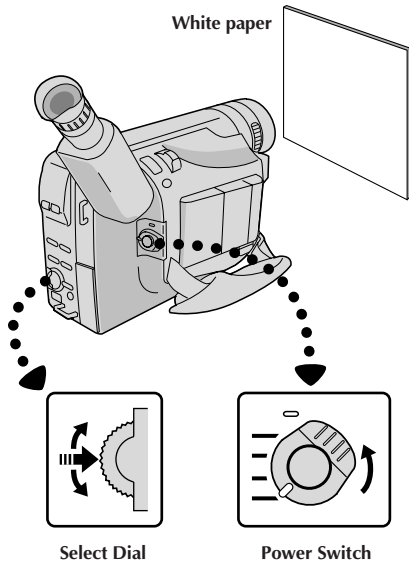

## Manual White Balance Operation

If the camera is operating in PRO. mode, perform a Manual White Balance when shooting under various types of lighting.

- 1 SELECT OPERATION MODE**  
Follow steps 1 through 4 of the white balance adjustment (☞ pg. 32), and select "MWB".
- 2 SET MANUAL WHITE BALANCE**  
Hold a sheet of plain white paper in front of the subject. Adjust zoom or position yourself so that the white paper fills the screen.
- 3 ENTER SETTING**  
Press the Select Dial until "MWB" begins blinking.
  - When the setting is completed, "MWB" stops blinking, and the Menu Screen reappears with the highlight bar on "RETURN".
- 4 CLOSE MENU SCREEN**  
Press the Select Dial again to close the Menu Screen.

### To Change The Tint For Recording . . .

.... in step 2, substitute colored paper for white. The white balance is adjusted based on the color, changing the tint. Red paper — deeper green; blue paper — orange; yellow paper — deeper purple.

### NOTES:

- In step 2, it may be difficult to focus on the white paper in some circumstances. In such a case, adjust focus manually (☞ pg. 31).
- A subject can be shot under various types of lighting conditions indoors (natural, fluorescent, candlelight, etc.). Because the color temperature is different depending on the light source, the tint of the subject will differ depending on the white balance settings. Use this function for a more natural result.
- Once you adjust white balance during Manual White Balance operation, the setting is retained even if the power is turned off or the battery removed.

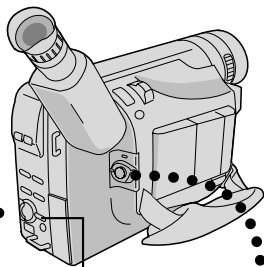

MENU Button

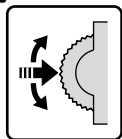

Select Dial

Display

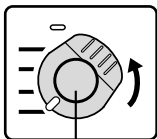

Recording Start/Stop Button

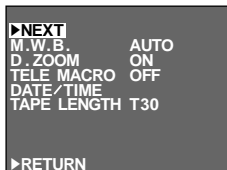

Menu Screen 1

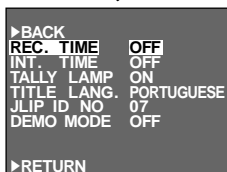

Menu Screen 2



INT. TIME Menu

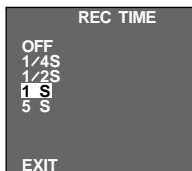

REC TIME Menu

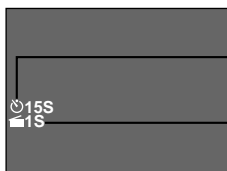

INT. TIME indicator

REC TIME indicator

INT. TIME and REC TIME indications on the normal screen

## Self-Timer

You can set the delay between pressing the Recording Start/Stop button and the actual start of recording. If you secure the camcorder, you (or whoever is operating the camcorder) can enter the scene before recording starts.

### NOTE:

Make sure the Power Switch is set to "PRO." and the camcorder is in the Record-Standby mode before performing the following steps.

## 1 ACCESS MENU SCREEN

Press MENU.

## 2 ACCESS "INT. TIME" MENU

Rotate the Select Dial to move the highlight bar to "NEXT" in Menu Screen 1 and press it to display Menu Screen 2. Then, move the highlight bar to "INT. TIME" and press it.

## 3 SET INTERVAL TIME

Rotate the Select Dial to move the highlight bar to the desired time, then press it. The Menu Screen reappears with the highlight bar on "RETURN".

## 4 CLOSE MENU SCREEN

Press the Select Dial.

## 5 START DELAYED RECORDING

Press the Recording Start/Stop Button. When the selected time has elapsed, recording begins automatically.

### To Cancel Self-Timer . . .

.... Before the recording begins, press the Recording Start/Stop Button to display "≡PAUSE≡", then set "INT. TIME" in the Menu Screen to "OFF".

## Animation

You can give stationary scenes or objects an illusion of movement. This function allows you to shoot a series of pictures, each slightly different, of the same object for a brief period of time.

### NOTE:

Before performing the following steps, make sure that:

- The Power Switch is set to "PRO."
- The camcorder is in the Record-Standby mode.
- The recording mode is set to "SP".

#### 1 ACCESS MENU SCREEN

Press MENU.

#### 2 SET RECORDING TIME

Rotate the Select Dial to move the highlight bar to "NEXT" in Menu Screen 1 and press it to display Menu Screen 2. Then, move the highlight bar to "REC TIME" and press it. The REC TIME Menu appears. Rotate the Select Dial to move the highlight bar to the desired time, then press it. The Menu Screen reappears with the highlight bar on "RETURN". Press the Select Dial again to close the Menu Screen.

#### 3 START RECORDING

Press the Recording Start/Stop Button after focusing on the subject. The recording stops automatically after the selected period of time.

#### 4 ASSEMBLE SERIES OF PICTURES

Repeat step 3 for the desired number of pictures.

#### 5 RELEASE ANIMATION MODE

Set "REC TIME" in the Menu screen to "OFF".

### NOTES:

- For best results, make sure the camcorder is secured when shooting in Animation or Time-Lapse mode.
- Fade- or wipe-in/out cannot be performed during Animation or Time-Lapse shooting.
- Before performing other operations following Animation or Time-Lapse recording, make sure the Animation or Time-Lapse mode is deactivated.
- Self-Timer, Animation and Time-Lapse are canceled when the power is shut off or when the cassette is ejected.

## Time-Lapse

You can record sequentially at preset time spans. Leaving the camcorder aimed at a specific subject, you can record subtle changes over an extended period of time.

### NOTE:

Before performing the following steps, make sure that:

- The Power Switch is set to "PRO."
- The camcorder is in the Record-Standby mode.
- The recording mode is set to "SP".

#### 1 ACCESS MENU SCREEN

Press MENU.

#### 2 SET INTERVAL BETWEEN RECORDINGS

Rotate the Select Dial to move the highlight bar to "NEXT" in Menu Screen 1 and press it to display Menu Screen 2. Then, move the highlight bar to "INT. TIME" and press it. The INT. TIME Menu appears. Rotate the Select Dial to move the highlight bar to the desired time, then press it. The Menu Screen reappears.

#### 3 SET RECORDING TIME

Rotate the Select Dial to move the highlight bar to "REC TIME", then press it. The REC TIME Menu appears. Rotate the Select Dial to move the highlight bar to the desired time, then press it. The Menu Screen reappears with the highlight bar on "RETURN". Press the Select Dial again to close the Menu Screen.

#### 4 START TIME-LAPSE RECORDING

Press the Recording Start/Stop Button. Recording and intervals alternate automatically.

#### 5 RELEASE TIME-LAPSE MODE

To release when "≡PAUSE≡" is displayed, set "REC TIME" and "INT. TIME" in the Menu Screen to "OFF". To release when "≡PAUSE≡" and "REC" are not displayed, press the Recording Start/Stop Button to display "≡PAUSE≡", then set "REC TIME" and "INT. TIME" in the Menu Screen to "OFF".

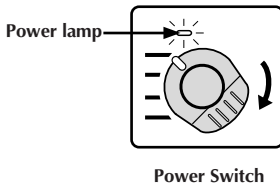
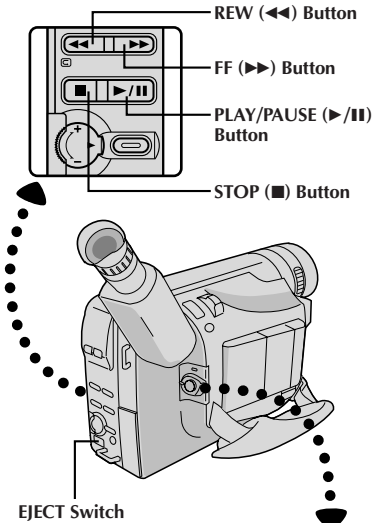

#### Battery pack remaining power indicator

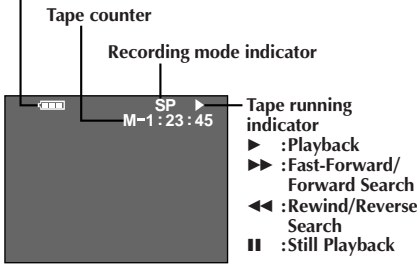

#### Viewfinder indications

## 1 LOAD A CASSETTE

Slide **EJECT** to open the cassette holder, then insert the cassette with the label facing out. Press **PUSH** to ensure the holder is closed and locked.

## 2 SELECT MODE

Set the Power Switch to "PLAY". The power lamp lights.

## 3 PLAY BACK

Press **PLAY/PAUSE** (▶/||). The playback picture appears.

## 4 STOP PLAYBACK

Press **STOP** (■).

## Rewind or Fast-Forward the tape

Press **REW** (◀◀) to rewind, or **FF** (▶▶) to fast-forward the tape during Stop mode.

### NOTES:

- The camcorder shuts off automatically after about 5 minutes in Stop mode. To turn on again, set the Power Switch to "POWER OFF", then to "PLAY".
- During Stop, Fast-Forward or Rewind mode, none of the indications are displayed in the viewfinder.
- If a blank portion on the tape is played back, the screen may become black. This is not a malfunction.

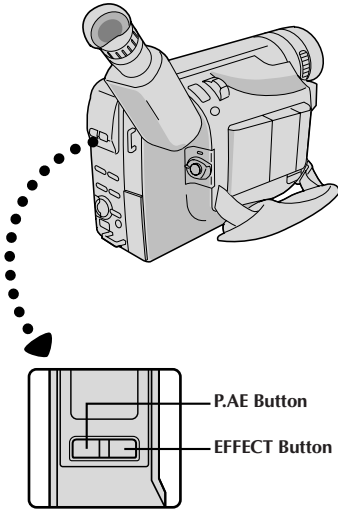

## Tracking

This function can be used to eliminate noise bars that appear on-screen during playback. Initial setting is Auto Tracking. Manual Tracking is also available.

### 1 ACTIVATE MANUAL TRACKING

Press **P.AE** and **EFFECT** simultaneously. Then, press **P.AE** or **EFFECT** as many times as necessary until the noise bars disappear.

- To return to Auto Tracking, press **P.AE** and **EFFECT** simultaneously. "AT" blinks. When Auto Tracking finishes, the indication disappears.

### NOTES:

- When noise bars appear during playback, the camcorder enters the Auto Tracking mode and "AT" is displayed.
- Manual Tracking may not work with tapes recorded on other VCRs or camcorders.

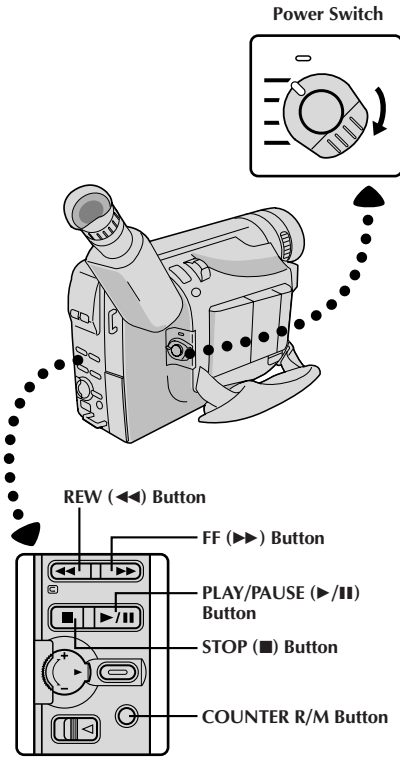
**FEATURE: Still Playback****PURPOSE:**

To pause during playback.

**OPERATION:**

- 1) Press **PLAY/PAUSE** (▶/||) during playback.
- 2) To resume normal playback, press **PLAY/PAUSE** (▶/||) again.

**NOTE:**

Noise bars appear and pictures may become monochrome during Still Playback. This is normal.

**FEATURE: Shuttle Search****PURPOSE:**

To allow high-speed search in either direction.

**OPERATION:**

- 1) Press **FF** (▶▶) to search forward or press **REW** (◀◀) to reverse during playback.
- 2) To resume normal playback, press **PLAY/PAUSE** (▶/||).

**NOTES:**

- During playback, press and hold **REW** (◀◀) or **FF** (▶▶). The search continues as long as you hold the button. Once you release it, normal playback resumes.
- Noise bars appear and pictures may become monochrome or darken during Shuttle Search. This is normal.

**FEATURE: Counter Memory Function****PURPOSE:**

To make it easier to locate a specific tape segment.

**OPERATION:**

- 1) Press **COUNTER R/M** and hold for more than 1 second. The counter resets to "0:00:00".
- 2) Press **COUNTER R/M** for less than 1 second. "M" appears.
- 3) After recording or playback, press **STOP** (■), then **REW** (◀◀). The tape automatically stops at or close to 0:00:00.
- 4) Press **PLAY/PAUSE** (▶/||) to start playback.

**NOTES:**

- The counter memory functions in the Fast-Forward and Rewind modes.
- To disable the Counter Memory Function, press **COUNTER R/M** for less than 1 second so that "M" disappears.

## Cassette Adapter (VHS Playpak)

Use this to play back a VHS-C video cassette recorded with this camcorder on a VHS VCR. It is fully compatible with any VHS video cassette recorder. The C-P7U adapter is battery powered and automatically performs tape loading and unloading.

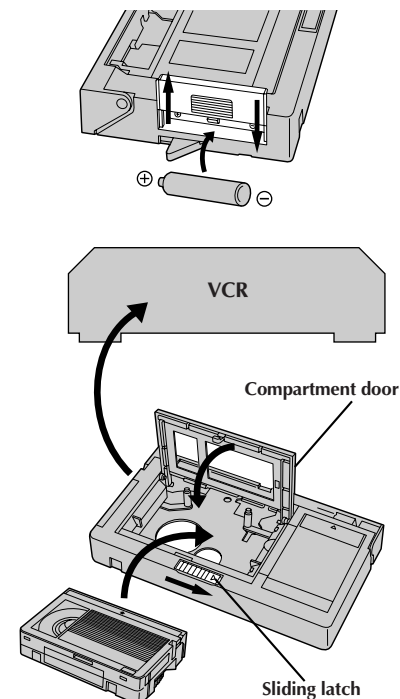

Compact video cassette

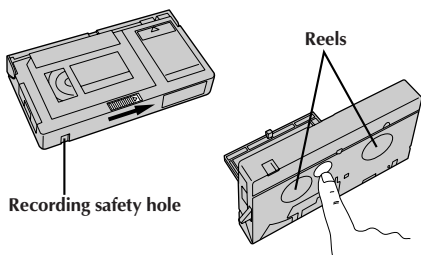

Recording safety hole

### 1 INSERT BATTERY

Slide the battery cover up to remove it, and install one "AA(R6)" size battery as shown in the illustration at left, then reattach the cover.

### 2 INSERT CASSETTE IN ADAPTER

Slide the latch to open the adapter compartment door, then insert the cassette and close the compartment door.

### 3 PLAY BACK ON CONNECTED VCR

Load the cassette adapter into the VCR and play the tape back as you would any other.

### 4 REMOVE CASSETTE FROM ADAPTER

Slide the latch and the compartment door opens automatically. This may take around 10 seconds. Do not attempt to force the adapter open. Then, insert your finger in the hole on the underside of the adapter as shown in the illustration at left, and push up and remove the cassette.

## NOTES:

- During tape loading and unloading, do not touch the reels for safety and tape protection.
- During special-effect playback (slow motion, still frame, etc.), the picture may vibrate or noise bars may appear on the screen.
- To record on a VCR using a compact cassette and the adapter, cover the adapter's recording safety hole with adhesive tape.

These are some basic types of connections. When making connections, refer also to your VCR and TV instruction manuals.

## Basic Connections

Use optional Video and Audio cables.

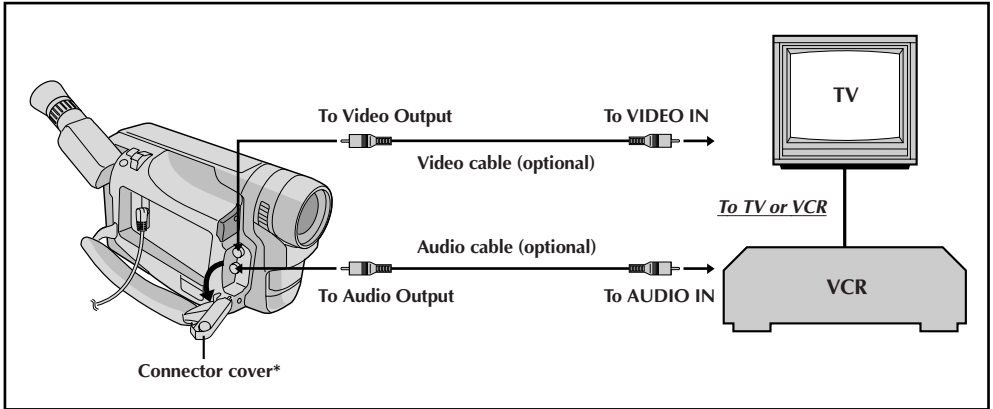

## Connection For Tape Dubbing

Use optional Video and Audio cables.

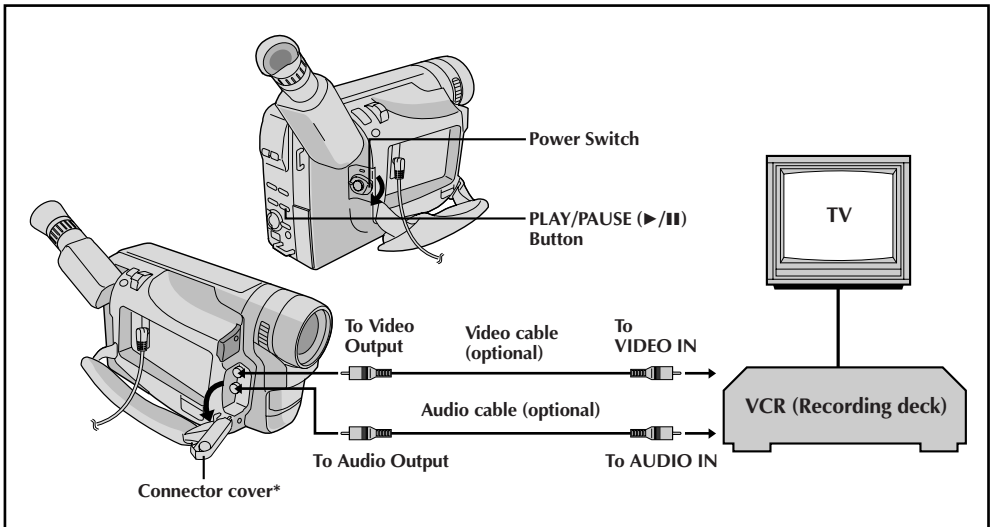

\* When connecting the cables, open this cover.



## Basic Connections

- 1 CONFIRM POWER-OFF STATUS**  
Make sure the camcorder's power is off.
- 2 CONNECT CAMCORDER TO TV OR VCR**  
Pull out the connector cover and open it.  
Connect as shown in the illustration (☞ pg. 40).  
*If using a VCR . . . go to step 3.*  
*If not . . . go to step 4.*
- 3 CONNECT VCR OUTPUT TO TV INPUT**  
Refer to your VCR's instruction manual.
- 4 SUPPLY POWER**  
Turn on the camcorder, the VCR and the TV.
- 5 SELECT MODE**  
Set the VCR to its AUX input mode, and set the TV to its VIDEO mode.

### NOTES:

- *It is recommended to use the AC Power Adapter/Charger as the power supply instead of the battery pack (☞ pg. 9).*
- *To monitor the picture and sound from the camcorder without inserting a tape, set the camcorder's Power Switch to "CAMERA" ("AUTO" or "PRO."), then set your TV to the appropriate input mode.*
- *Make sure you adjust the TV sound volume to its minimum level to avoid a sudden burst of sound when the camcorder is turned on.*
- *If you have a TV or speakers that are not specially shielded, do not place the speakers adjacent to the TV as interference will occur in the camcorder playback picture.*

## Tape Dubbing

- 1 CONNECT EQUIPMENT**  
Following the illustration on pg. 40, connect the camcorder and the VCR.
- 2 PREPARE FOR DUBBING**  
Set the camcorder's Power Switch to "PLAY", turn on the VCR's power, and insert the appropriate cassettes in the camcorder and the VCR.
- 3 SELECT VCR MODE**  
Engage the VCR's AUX and Record-Pause modes.
- 4 FIND EDIT-IN POINT**  
Engage the camcorder's Play mode to find a spot just before the edit-in point. Once it is reached, press **PLAY/PAUSE** (▶/||) on the camcorder.
- 5 START EDITING**  
Press **PLAY/PAUSE** (▶/||) on the camcorder and engage the VCR's Record mode.
- 6 STOP EDITING TEMPORARILY**  
Engage the VCR's Record-Pause mode and press **PLAY/PAUSE** (▶/||) on the camcorder.
- 7 EDIT MORE SEGMENTS**  
Repeat steps 4 through 6 for additional editing, then stop the VCR and camcorder when finished.

LENS COVER Open/Close Ring

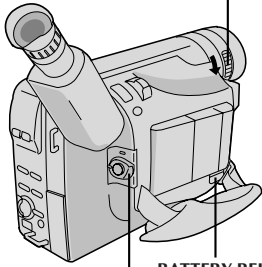

Set to "POWER OFF".

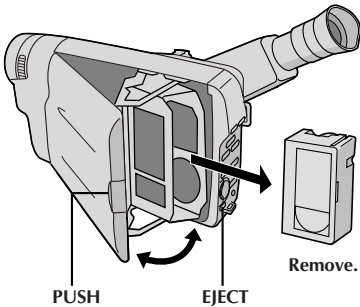

Remove.

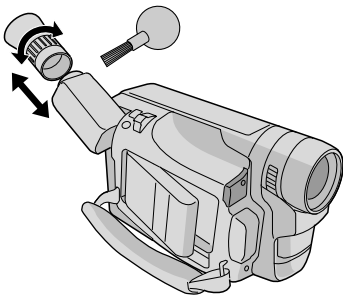

## After Use

- 1** Set the Power Switch to "POWER OFF" to turn off the camcorder.
- 2** Slide **EJECT** to open the cassette holder, then remove the cassette.
- 3** Close and lock the cassette holder by pressing **PUSH**.
- 4** Slide **BATTERY RELEASE** to remove the battery pack.
- 5** Turn the **LENS COVER Open/Close Ring** to close the lens cover.

## Cleaning The Camcorder

- 1 CLEAN EXTERIOR**  
Wipe gently with a soft cloth.
  - Put cloth in diluted mild soap and wring it well to wipe off heavy dirt, then wipe again with a dry cloth.
- 2 CLEAN LENS**  
Blow it with a blower brush, then wipe it gently with lens cleaning paper.
- 3 REMOVE EYEPIECE**  
Turn the eyepiece counterclockwise and pull it out.
- 4 CLEAN VIEWFINDER**  
Remove dust using a blower brush.
- 5 RE-ATTACH EYEPIECE**  
Re-attach the eyepiece and turn it clockwise.

## NOTES:

- Avoid using strong cleaning agents such as benzine or alcohol.
- Cleaning should be done only after the battery pack has been removed or other power units have been disconnected.
- Mold may form if the lens is left dirty.
- When using a cleaner or chemically treated cloth, refer to the cautions that came with it.
- When removing the eyepiece, be sure to hold the viewfinder securely.

If, after following the steps in the chart below, the problem still exists, please consult your JVC dealer.

The camcorder is a microcomputer-controlled device. External noise and interference (from a TV, a radio, etc.) might prevent it from functioning properly. In such cases, first disconnect its power supply unit (battery pack, AC Power Adapter/Battery Charger, etc.) and clock battery; and then re-connect it and proceed as usual from the beginning.

SYMPTOM	POSSIBLE CAUSE(S)
<b>POWER</b>	
No power is supplied.	<ul style="list-style-type: none"> <li>● The battery pack has not been attached correctly (☞ pg. 8).</li> <li>● The battery pack is not charged (☞ pg. 8).</li> <li>● The power supply has not been correctly connected (☞ pg. 9).</li> </ul>
The power suddenly goes off and does not come back on by itself.	<ul style="list-style-type: none"> <li>● The battery pack has completely discharged.</li> <li>● Remove the cassette and disconnect the power source, then after a few minutes, try turning the power back on. If it still does not come on, consult your nearest JVC dealer.</li> </ul>
<b>RECORDING</b>	
Recording cannot be performed.	<ul style="list-style-type: none"> <li>● Make sure the Erase Protection tab is in the position that allows recording. If not, slide the tab. Some cassettes have removable tabs. If the tab has been removed, cover the hole with adhesive tape.</li> </ul>
Recording does not start.	<ul style="list-style-type: none"> <li>● The camcorder Power Switch has not been set to "CAMERA" ("AUTO" or "PRO".) (☞ pg. 16).</li> </ul>
Animation or Time-Lapse is not available.	<ul style="list-style-type: none"> <li>● Before recording in the Animation mode at the very beginning of a tape, set the camcorder to the Recording mode for about 5 seconds, so that the tape runs smoothly. Using the Fade-in function at this point is a good way to begin an animated program (☞ pg. 35).</li> </ul>
<b>PLAYBACK</b>	
The tape is running, but there is no playback picture.	<ul style="list-style-type: none"> <li>● The TV has not been set to its VIDEO mode or channel.</li> <li>● If A/V connection is used, the TV's VIDEO/TV Switch has not been set to VIDEO.</li> </ul>
Playback picture is blurred or interrupted.	<ul style="list-style-type: none"> <li>● The video heads are dirty or worn out. Consult your nearest JVC dealer for head cleaning or replacement.</li> </ul>
The counter indication is blurred during Still playback.	<ul style="list-style-type: none"> <li>● This is normal.</li> </ul>
<b>TAPE TRANSPORT</b>	
The tape stops during fast-forward or rewind.	<ul style="list-style-type: none"> <li>● The Counter Memory Function has been activated (☞ pg. 38).</li> </ul>
Rewinding or fast-forwarding cannot be performed.	<ul style="list-style-type: none"> <li>● The tape is already fully wound on one reel or the other.</li> </ul>



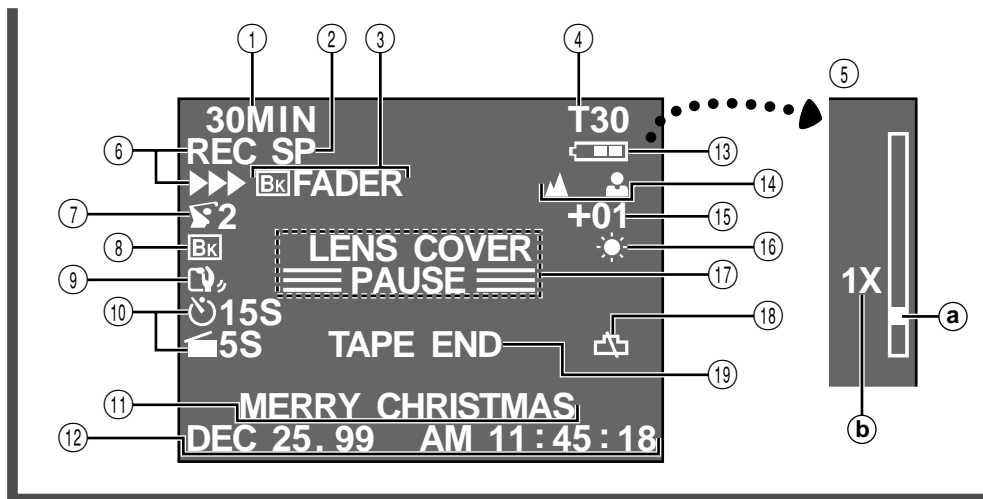



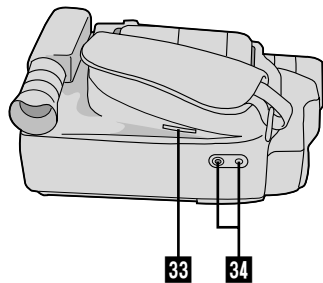
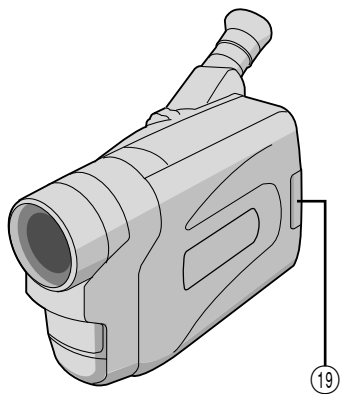
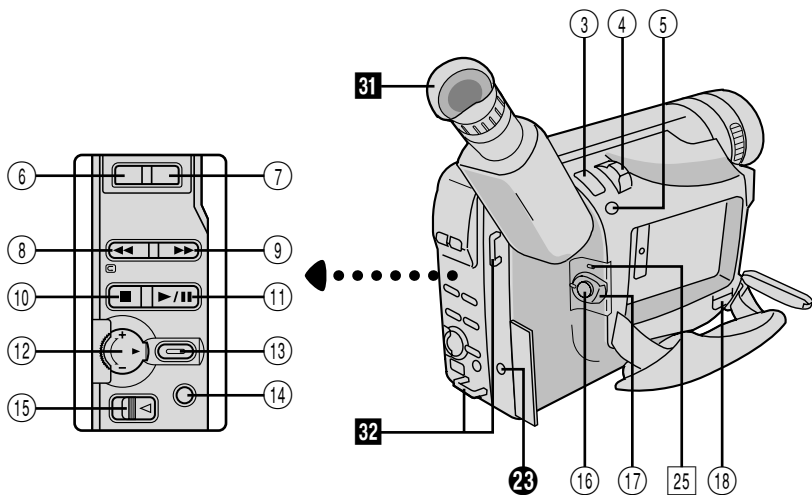
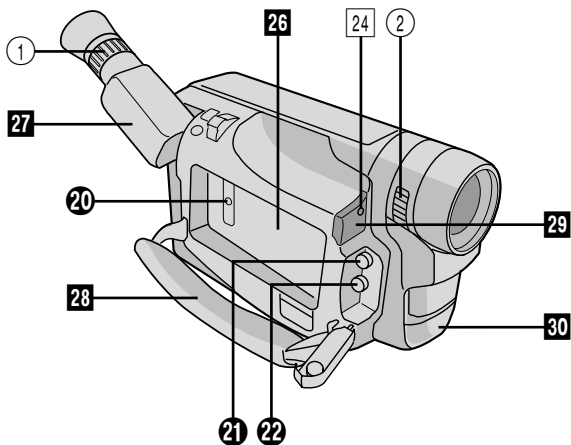















SYMPTOM	POSSIBLE CAUSE(S)
<b>OTHER</b>	
During recording, the indications do not appear.	<ul style="list-style-type: none"> <li>● Press <b>DISPLAY</b> for longer than 1 second to make the indications appear (☞ pg. 17).</li> </ul>
The tape will not eject.	<ul style="list-style-type: none"> <li>● The battery pack is running low.</li> </ul>
Some functions are not available.	<ul style="list-style-type: none"> <li>● The Power Switch is set to "AUTO".</li> <li>● Certain combinations of modes or effects are not possible to use.</li> </ul>
Vertical white lines appear when shooting a very bright object.	<ul style="list-style-type: none"> <li>● This sometimes occurs when the contrast between the background and the object is great. It is not a defect of the camcorder.</li> </ul>
Bright, crystal-shaped spots appear in the viewfinder.	<ul style="list-style-type: none"> <li>● Sunlight is directly entering the lens. This is not a defect of the camcorder.</li> </ul>
Colored bright spots appear all over the viewfinder.	<ul style="list-style-type: none"> <li>● The viewfinder is made with high-precision technology. However, black spots or bright spots of light (red, green or blue) may appear constantly in the viewfinder. These spots are not recorded on the tape. This is not due to any defect of the unit. (Effective dots: more than 99.99 %.)</li> </ul>
The viewfinder and the lens have become dirty (ex. fingerprints).	<ul style="list-style-type: none"> <li>● Wipe them gently with a soft cloth. Gently wipe in a semicircular motion, as wiping strongly spreads the stain and it won't come out easily.</li> </ul>
The picture is blurred in the Quick Review or Retake mode.	<ul style="list-style-type: none"> <li>● This is normal while recording in the EP mode. Some noise may be present while recording in the SP mode (☞ pg. 12).</li> </ul>
An error number (i.e. E03) appears.	<ul style="list-style-type: none"> <li>● Turn the camcorder's power off, then disconnect the power source. After a few minutes, try turning the power on again. If the error number still appears in the viewfinder, consult your nearest JVC dealer.</li> </ul>
The image is out of focus.	<ul style="list-style-type: none"> <li>● The diopter needs to be adjusted (☞ pg. 14).</li> <li>● The scene being shot is adversely affecting the operation of Auto Focus (☞ pg. 30).</li> </ul>
The date and time displays disappear.	<ul style="list-style-type: none"> <li>● If you remove the power source from the camcorder while the power is on, all settings and selections are erased. Make sure to turn the camcorder's power off before disconnecting the power source.</li> </ul>
The wrong date and time are displayed/recorded.	<ul style="list-style-type: none"> <li>● If you have not performed Date/Time Setting (☞ pg. 11), the date and time are not displayed/recorded correctly. Be sure that Date/Time setting is carried out.</li> </ul>
Even though the lens cover is open, the Lens Cover Warning indicator blinks.	<ul style="list-style-type: none"> <li>● The Lens Cover Warning indicator may blink when the camcorder is used in dark areas, regardless of the position of the lens cover.</li> </ul>





- ① **Cassette Warning/**  
Tape Remaining Time ..... pg. 17  
When no cassette is inserted: the cassette () warning blinks.  
When the Erase Protection tab is not in the position that allows recording: the cassette () warning lights. Otherwise, the tape remaining time is displayed and the tape remaining time warning blinks when the tape is about to reach its end.  
When the Power Switch is set to "PLAY" and a tape is loaded: the cassette () mark is displayed regardless of the Erase Protection tab's position.
- ② **Recording Mode (SP/EP) Indicator** ..... pg. 12
- ③, ⑦ **Program AE Indicator** ..... pg. 22  
Displayed at ③ for approx. 2 seconds when Program AE with special effects is switched from one mode to another by pressing **P.AE.**, then only the indicator remains at ⑦.
- ③, ⑧ **Fade/Wipe-Standby Indicator** ..... pg. 21  
Displayed at ③ for approx. 2 seconds when the Fade/Wipe is switched from one effect to another by pressing **EFFECT**, then only the indicator remains at ⑧.
- ④ **Tape Length Indicator** ..... pg. 12
- ⑤ **Zoom Indicator Bar** ..... pg. 18  
  - Ⓐ **Zoom Level Indicator**
  - Ⓑ **Approximate Zoom Ratio**
- ⑥ **Recording Indicator** ..... pg. 16
- ⑨ **Picture Stabilizer Indicator** ..... pg. 20
- ⑩ **Interval Timer/Recording Time Indicator** ..... pg. 34  
  - 5 Sec. Rec Mode Indicator ..... pg. 20
- ⑪ **Instant Title Display** ..... pg. 25
- ⑫ **Date/Time Display** ..... pg. 24
- ⑬ **Battery Pack Remaining Power Indicator**  
Changes as follows according to the battery pack's remaining power level:  
"→→→". When the power is almost gone, the indicator "" blinks (battery power warning), then the unit shuts off. Replace the battery pack with a fully charged one.  
**Note:** The symbol containing 3 darkened squares — — does not necessarily mean that the battery pack is fully charged.
- ⑭ **Focus Indicator** ..... pg. 31
- ⑮ **Exposure Control Level Counter** ..... pg. 29
- ⑯ **White Balance Mode Indicator** ..... pg. 32
- ⑰ **Record-Standby Mode Indicator** ..... pg. 16  
  - **Lens Cover Warning:**  
LENS COVER ..... pg. 17
- ⑱ **Clock Battery Warning**  
Blinks for approx. 10 seconds when the power is turned on. This display also blinks when the clock (lithium) battery is either not installed or has discharged. Install or replace the old battery with a new one ( pg. 10).  
  - **Tape End Display: TAPE END** ..... pg. 17  
Appears when the end of the tape is reached during playback, recording or fast-forward.
  - **Condensation Warning:**   
When this indication appears, all functions except tape eject and power on/off are disabled. Turn the unit off (without removing the power source) for a few hours, and when you turn it on again the indication should disappear.
  - **Head Clog Warning:**   
Appears if dirty heads are detected during recording. In such a case, use the optional Cleaning Cassette. If, after using it, the problems still exist, consult your nearest JVC dealer.





## Controls

- ① Diopter Adjustment Control .....  pg. 14
- ② Lens Cover Open/Close Ring .....  pg. 16
- ③ 5-Second Recording Button  
[5SEC. REC] .....  pg. 20
- ④ Power Zoom Lever [T/W] .....  pg. 18
- ⑤ Picture Stabilizer Button  
[P.STABILIZER] .....  pg. 20
- ⑥ Program AE Button [P.AE] .....  pg. 22
- ⑦ Fade/Wipe Button [EFFECT] .....  pg. 21
- ⑧ • Rewind Button [◀◀, REW] .....  pg. 36  
• Retake Rewind Button [RETAKE R] .....  pg. 19  
• Quick Review Button [☐R] .....  pg. 19
- ⑨ • Fast-Forward Button [▶▶, FF] .....  pg. 36  
• Retake Forward Button [RETAKE F] .....  pg. 19
- ⑩ Stop Button [■, STOP] .....  pg. 36
- ⑪ Play/Pause Button  
[▶/⏸, PLAY/PAUSE] .....  pg. 36
- ⑫ Select Dial [+ , - , PUSH] .....  pg. 11, 26
- ⑬ MENU/DISPLAY Button .....  pg. 17, 26
- ⑭ • Counter Reset/Memory Button  
[COUNTER R/M] .....  pg. 38  
• Recording Mode Button [SP/EP] .....  pg. 12
- ⑮ EJECT Switch .....  pg. 13
- ⑯ Recording Start/Stop Button .....  pg. 16
- ⑰ Power Switch .....  pg. 16, 36
- ⑱ Battery Release Switch  
[BATTERY RELEASE] .....  pg. 8
- ⑲ PUSH Button .....  pg. 13







## Connectors

- ⑳ DC IN Jack .....  pg. 9
- The connectors ㉑ to ㉓ are located beneath the cover.
- ㉑ Video Output Connector .....  pg. 40
  - ㉒ Audio Output Connector .....  pg. 40
  - ㉓ J Terminal [JLIP (Joint Level Interface Protocol) Connector]
    - It is used to connect the camcorder to a device such as a personal computer. For further details consult your nearest JVC dealer.
    - JLIP-controlled editing from camcorder to VCR is not possible if the VCR is not equipped with a J terminal.





## Indicators

- ㉔ Tally Lamp .....  pg. 16
- ㉕ Power Lamp .....  pg. 16

## Other Parts

- ㉖ Battery Pack Mount .....  pg. 8
- ㉗ Viewfinder .....  pg. 14
- ㉘ Grip Strap .....  pg. 14
- ㉙ Camera sensor  
Be careful not to cover this area; a sensor necessary for shooting is built-in here.
- ㉚ Microphone  
For use when recording.
- ㉛ Eyepiece .....  pg. 42
- ㉜ Shoulder Strap Eyelets .....  pg. 15
- ㉝ Clock Battery Slot .....  pg. 10
- ㉞ Tripod Mounting Socket .....  pg. 15







**A**

- AC Power Adapter/Charger .....  pg. 8, 9
- Animation Recording .....  pg. 35
- Auto Date Record .....  pg. 24
- Auto Focus .....  pg. 30
- Auto Shut off .....  pg. 17, 36







**B**

- Battery Pack .....  pg. 8, 9, 49

**C**

- Car Battery .....  pg. 9
- Charge Marker .....  pg. 9
- Charge The Battery Pack .....  pg. 8
- Clean The Camcorder .....  pg. 42
- Clock (Lithium) Battery .....  pg. 10
- Connections .....  pg. 9, 40

**D**

- Date/Time Display .....  pg. 24
- Date/Time Settings .....  pg. 11
- Demonstration Mode .....  pg. 28
- Digital Zoom .....  pg. 27
- Discharge The Battery Pack .....  pg. 8
- Diopter Adjustment .....  pg. 14
- Dubbing .....  pg. 41

**E**

- Electronic Fog Filter Mode .....  pg. 23
- Erase Protection .....  pg. 13
- Exposure Control .....  pg. 29

**F**

- Fade-In/Out .....  pg. 21
- Fast-Forward Tape .....  pg. 36
- 5-Sec. Recording .....  pg. 20

**G**

- Grip Adjustment .....  pg. 14

**H**

- High Speed Shutter Mode .....  pg. 23

**I**

- Instant Titles .....  pg. 25



**L**

- Load A Tape .....  pg. 13

**M**

- Manual Focus .....  pg. 31
- Menu Screen .....  pg. 27, 28

**N**

- ND Effect Mode .....  pg. 23
- Nega/Posi Mode .....  pg. 23

**P**

- Picture Stabilizer .....  pg. 20
- Power Switch Position .....  pg. 16
- Program AE With Special Effects .....  pg. 22
- Provided Accessories .....  pg. 6

**Q**

- Quick Review .....  pg. 19









**R**

- Record-Standby .....  pg. 16
- Recording Mode .....  pg. 12
- Retake .....  pg. 19
- Rewind The Tape .....  pg. 36

**S**

- Self-Timer .....  pg. 34
- Sepia .....  pg. 23
- Shoulder Strap Attachment .....  pg. 15
- Shuttle Search .....  pg. 38
- Specifications .....  pg. 51
- Still Playback .....  pg. 38
- Super LoLux (S.LX) .....  pg. 27

**T**

- Tally .....  pg. 28
- Tape Counter .....  pg. 36
- Tape Length Setting .....  pg. 12
- Tele Macro .....  pg. 27
- Time-Lapse Shooting .....  pg. 35
- Tracking .....  pg. 37
- Tripod Mounting .....  pg. 15
- Twilight .....  pg. 23

**U**

- Unload A Tape .....  pg. 13

**V**

- Viewfinder Indications .....  pg. 45

**W**

- White Balance .....  pg. 32, 33
- Wide Mode .....  pg. 27
- Wipe In/Out .....  pg. 21

**Z**

- Zooming .....  pg. 18



## When using the AC Power Adapter/Charger in areas other than the USA

- The provided AC Power Adapter/Charger features automatic voltage selection in the AC range from 110 V to 240 V.

### USING HOUSEHOLD AC PLUG ADAPTER

In case of connecting the unit's power cord to an AC wall outlet other than American National Standard C73 series type use an AC plug adapter, called a "Siemens Plug", as shown.

For this AC plug adapter, consult your nearest JVC dealer.

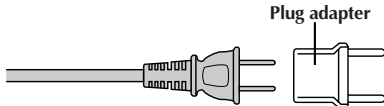

### INFORMATION

This device complies with Part 15 of FCC Rules.

Operation is subject to the following two conditions:

- (1) This device may not cause harmful interference, and
- (2) this device must accept any interference received, including interference that may cause undesired operation. Change or modifications not approved by the party responsible for compliance could void the user's authority to operate the equipment. This equipment has been tested and found to comply with the limits for a Class B digital device, pursuant to Part 15 of the FCC Rules. These limits are designed to provide reasonable protection against harmful interference in a residential installation. This equipment generates, uses, and can radiate radio frequency energy and, if not installed and used in accordance with the instructions, may cause harmful interference to radio or television reception. However, there is no guarantee that interference will not occur in a particular installation. If this equipment does cause harmful interference to radio or television reception, which can be determined by turning the equipment off and on, the user is encouraged to try to correct the interference by one or more of the following measures:

- Reorient or relocate the receiving antenna.
- Increase the separation between the equipment and receiver.
- Connect the equipment into an outlet on a circuit different from that to which the receiver is connected.
- Consult the dealer or an experienced radio/TV technician for help.

## General Battery Precautions

- When the C-P6U or C-P7U (cassette adapter) is not functioning even when correctly operated, the battery is exhausted. Replace it with a fresh one.
- Use only the following battery:  
C-P6U or C-P7U ..... AA (R6) size

Please make note of the following rules for battery use. When misused, the battery can leak or explode.

1. Refer to the C-P6U/C-P7U instructions when replacing the battery.
2. **Do not** expose the battery to excessive heat as it can leak or explode.
3. **Do not** dispose of the battery in a fire.
4. Remove the battery from the unit if it is to be stored for an extended period to avoid battery leakage which can cause malfunctions.

## Battery Packs

The supplied battery pack is a nickel-cadmium battery. Before using the supplied battery pack or an optional battery pack, be sure to read the following cautions:

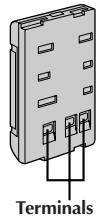

1. **To avoid hazard . . .**
  - .... do not burn.
  - .... do not short-circuit the terminals.
  - .... do not modify or disassemble.
  - .... use only specified chargers.
2. **To prevent damage and prolong service life . . .**
  - .... do not subject to unnecessary shock.
  - .... avoid repeated charging without fully discharging.
  - .... charge in an environment where temperatures are within the tolerances shown in the chart below.  
This is a chemical reaction type battery—cooler temperatures impede chemical reaction, while warmer temperatures can prevent complete charging.
  - .... store in a cool, dry place. Extended exposure to high temperatures will increase natural discharge and shorten service life.
  - .... avoid prolonged uncharged storage.
  - .... remove from charger or powered unit when not in use, as some machines use current even when switched off.

### NOTES:

- It is normal for the battery pack to be warm after charging, or after use.  
*Temperature Range Specifications*  
Charging ..... 10°C to 35°C (50°F to 95°F)  
Operation ..... 0°C to 40°C (32°F to 104°F)  
Storage ..... -10°C to 30°C (14°F to 86°F)
- Recharging time is based on room temperature of 20°C (68°F).
- The lower the temperature, the longer recharging takes.

## Cassettes

To properly use and store your cassettes, be sure to read the following cautions:

### 1. During use . . .

- .... make sure the cassette bears the VHS-C mark.
- .... be aware that recording onto prerecorded tapes automatically erases the previously recorded video and audio signals.
- .... make sure the cassette is positioned properly when inserting.
- .... do not load and unload the cassette repeatedly without allowing the tape to run at all. This slackens the tape and can result in damage.
- .... do not open the front tape cover. This exposes the tape to fingerprints and dust.

### 2. Store cassettes . . .

- .... away from heaters or other heat sources.
- .... out of direct sunlight.
- .... where they won't be subject to unnecessary shock or vibration.
- .... where they won't be exposed to strong magnetic fields (such as those generated by motors, transformers or magnets).
- .... vertically, in their original cases.

## Main Unit

### 1. For safety, DO NOT . . .

- .... open the camcorder's chassis.
- .... disassemble or modify the unit.
- .... short-circuit the terminals of the battery pack.
  - Keep it away from metallic objects when not in use.
- .... allow inflammables, water or metallic objects to enter the unit.
- .... remove the battery pack or disconnect the power supply while the power is on.
- .... leave the battery pack attached when the camcorder is not in use.

### 2. Avoid using the unit . . .

- .... in places subject to excessive humidity or dust.
- .... in places subject to soot or steam such as near a cooking stove.
- .... in places subject to excessive shock or vibration.
- .... near a television set.
- .... near appliances generating strong magnetic or electric fields (speakers, broadcasting antennas, etc.).
- .... in places subject to extremely high (over 40°C or 104°F) or extremely low (under 0°C or 32°F) temperatures.

### 3. DO NOT leave the unit . . .

- .... in places of over 50°C (122°F).
- .... in places where humidity is extremely low. (below 35%) or extremely high (above 80%).
- .... in direct sunlight.
- .... in a closed car in summer.
- .... near a heater.

### 4. To protect the unit, DO NOT . . .

- .... allow it to become wet.
- .... drop the unit or strike it against hard objects.
- .... subject it to shock or excessive vibration during transportation.
- .... keep the lens directed at extremely bright objects for long periods.
- .... direct the eyepiece of the viewfinder at the sun.
- .... carry it by holding the viewfinder. Be sure to hold the main unit with both hands or use the grip.
- .... swing it excessively when using the shoulder strap.

### About moisture condensation . . .



- You may have observed that pouring a cold liquid into a glass will cause drops of water to form on the glass' outer surface. This same phenomenon occurs on the head drum of a camcorder when it is moved from a cool place to a warm place, after heating a cold room, under extremely humid conditions or in a place directly subjected to the cool air from an air conditioner.
- Moisture on the head drum can cause severe damage to the video tape, and can lead to internal damage to the camcorder itself.

### Serious malfunctioning

If malfunctioning occurs, stop using the unit immediately and consult your local JVC dealer.

## Camcorder



### General

<b>Format</b>	: VHS NTSC standard	<b>Operating temperature</b>	: 0°C to 40°C (32°F to 104°F)
<b>Power source</b>	: DC 6.0 V 	<b>Operating humidity</b>	: 35% to 80%
<b>Power consumption</b>	: 5.4 W	<b>Storage temperature</b>	: -20°C to 50°C (-4°F to 122°F)
<b>Signal system</b>	: NTSC-type	<b>Weight</b>	: Approx. 710 g (1.6 lbs)
<b>Video recording system</b>		<b>Dimensions</b>	: 91 (W) x 119 (H) x 198 (D) mm (3-8/5" x 4-11/16" x 7-13/16") (with the viewfinder fully tilted downward)
<b>Luminance</b>	: FM recording	<b>Pickup</b>	: 1/4" format CCD
<b>Color</b>	: Converted sub-carrier direct recording Conforms to VHS standard	<b>Lens</b>	: F1.6, f = 3.9 to 62.4 mm, 16:1 power zoom lens with auto iris and macro control, filter diameter 40.5 mm
<b>Cassette</b>	:  cassette	<b>Viewfinder</b>	: Electronic viewfinder with 0.55" color LCD
<b>Tape speed</b>		<b>White balance adjustment</b>	: Auto/Manual adjustment
<b>SP</b>	: 33.35 mm/sec. (1-5/16 ips)		
<b>EP</b>	: 11.12 mm/sec. (7/16 ips)		
<b>Recording time (max.)</b>			
<b>SP</b>	: 40 minutes		
<b>EP</b>	: 120 minutes (with TC-40)		

### Connectors

<b>JLIP</b>	: ø3.5 mm, 4-pole, mini-head jack (compatible with RC-5325 plug)	<b>Video</b>	: 1 Vp-p, 75 Ω unbalanced, analog output (via Video output connector)
		<b>Audio</b>	: -8 dBs, 1 kΩ analog output (via Audio output connector)

### AC Power Adapter/Charger AA-V15U

<b>Power requirement</b>	
<b>U.S.A. and Canada</b>	: AC 120 V~, 60 Hz
<b>Other countries</b>	: AC 110 V to 240 V~, 50/60 Hz
<b>Power consumption</b>	: 23 W
<b>Output</b>	
<b>Charge</b>	: DC 8.5 V  , 1.3 A
<b>VTR</b>	: DC 6.3 V  , 1.8 A
<b>Charging system</b>	: Constant current, peak detection, timer controlled
<b>Dimensions</b>	: 140 (W) x 42 (H) x 68 (D) mm (5-9/16" x 1-11/16" x 2-11/16")
<b>Weight</b>	: Approx. 300 g (0.71 lbs)

### Cassette Adapter C-P7U

<b>Dimensions</b>	: 188 (W) x 25 (H) x 104 (D) mm (7-7/16" x 1" x 4-1/8")
<b>Weight</b>	: Approx. 240 g (0.53 lbs)
<b>Accessory</b>	: "AA (R6)"-size battery x 1

**Provided Accessories** .....  **pg. 6**

### Optional Accessories

- Battery Packs BN-V12U, BN-V20U, BN-V856U
- Car Battery Charger BH-V3U
- Battery Charger BH-VC10U
- Car Battery Cord AP-V7U
- Compact VHS-C Cassettes TC-40/30/20
- Active Carrying Bag CB-V7U
- Audio/Video Cable

Some accessories are not available in some areas. Please consult your nearest JVC dealer for details on accessories and their availability.

*Specifications shown are for SP mode unless otherwise indicated. E & O.E. Design and specifications subject to change without notice.*

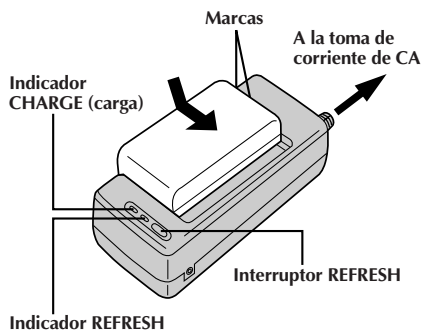

### REFRESCADO (REFRESH)

El adaptador de CA se caracteriza por la función REFRESH que le permite descargar totalmente la batería antes de recargarla.

Efectúe la función REFRESH después de un mínimo de 5 cargas.

#### Para descargar la batería . . .

.... coloque la batería en el adaptador como se muestra en la ilustración de arriba. Luego presione REFRESH. El indicador REFRESH se enciende cuando se inicia la descarga y se apaga cuando la descarga ha terminado.

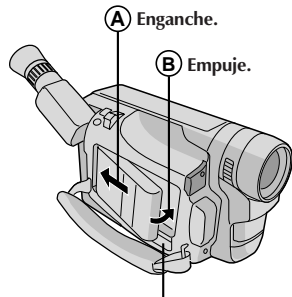

BATTERY RELEASE

### ATENCIÓN:

Antes de desmontar la fuente de alimentación, asegúrese que la alimentación de la cámara de video esté desconectada. El no hacerlo puede producir un error de funcionamiento en la cámara de video.



#### Indicador de carga

Se incorpora un indicador de carga sobre la batería para ayudarle a recordar si ha sido cargada o no. Los dos colores indicadores (rojo y negro), le permiten seleccionar la carga y la descarga.

## Alimentación

Esta cámara de video posee un sistema de alimentación de 3 vías que le permite seleccionar la fuente de alimentación más apropiada.

### NOTAS:

- Sin alimentación no hay ninguna función disponible.
- Utilice exclusivamente la alimentación indicada.
- No utilice las unidades de alimentación suministradas con otro equipo.

## CARGA DE LA BATERIA

### 1 ALIMENTACION

Conecte el cable de alimentación de CA del cargador a una toma de corriente.

### 2 COLOCACION DE LA BATERIA

Alinee las marcas y deslice la batería en la dirección de la flecha hasta que quede bloqueada en su lugar.

- El indicador CHARGE comienza a destellar para indicar que se ha iniciado la carga.

### 3 EXTRACCION DE LA BATERIA

Cuando el indicador CHARGE deja de destellar y permanece encendido, la carga ha terminado. Deslice la batería en el sentido opuesto al de la flecha.

Batería	Tiempo de carga	Tiempo de descarga
BN-V11U	aprox. 1 h 10 min	aprox. 3 h 30 min
BN-V12U	aprox. 1 h 10 min	aprox. 3 h 30 min
BN-V20U	aprox. 1 h 50 min	aprox. 6 h 40 min

## USO DE LA BATERIA

### 1 COLOCACION DE LA BATERIA

Enganche el lado extremo de la batería en la cámara de video (A) y empuje la batería hasta que se bloquee en el lugar (B).

### 2 EXTRACCION DE LA BATERIA

Deslice BATTERY RELEASE y extraiga la batería.

Batería	Tiempo de grabación aproximado (unidad: min)
BN-V11U	70
BN-V12U	70
BN-V20U	110

## INFORMACION:

El VU-V856KIT es un juego compuesto de la batería BN-V856U y del cargador/adaptador de CA AA-V80U. La batería BN-V856U suministra aprox. 7 horas de tiempo de grabación. También lea completamente los manuales de instrucción del VU-V856KIT.

Es imposible cargar la batería BN-V856U utilizando el cargador/adaptador de CA suministrado. Use el cargador/adaptador de CA AA-V80U opcional.

Si la unidad comienza a funcionar mal, deje de usarla inmediatamente y consulte a su concesionario local de JVC.

## ALIMENTACION

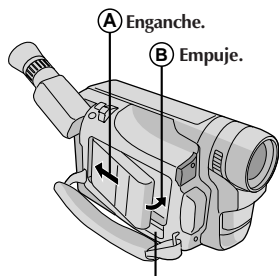

### Utilización de la batería

Enganche el lado extremo de la batería en la cámara de video (A) y empuje la batería hasta que se bloquee en el lugar (B).  
(Procedimiento para carga, ☞ p. 8)

### Para extraer la batería

Deslice **BATTERY RELEASE** y extraiga la batería.

## INSERCIÓN DEL CASSETTE DE VIDEO

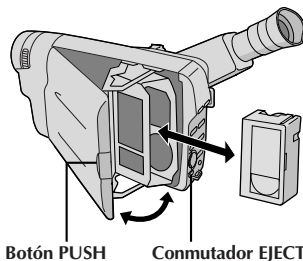

- 1 Deslice **EJECT** para abrir el portacassette.
- 2 Inserte cassette de video.
- 3 Presione **PUSH** para cerrar el portacassette.  
(Por más detalles, ☞ p. 13.)

## REPRODUCCION

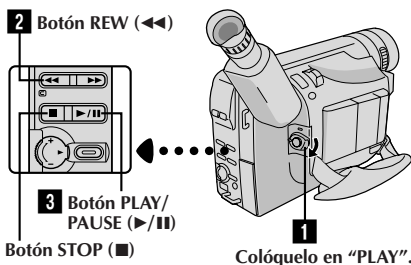

- 1 Ajuste el interruptor de alimentación en "PLAY".
  - 2 Presione **REW** (◀◀).  
— La cinta se detiene automáticamente al comienzo de la misma.
  - 3 Presione **PLAY/PAUSE** (▶/||).  
— Comienza la reproducción y la imagen aparece.
- Presione **STOP** (■) para detener la grabación.  
(Por más detalles, ☞ p. 36.)

O simplemente reproduzca la cinta en un VCR de VHS utilizando el adaptador de cassette (VHS Playpak). ☞ p. 39

## FILMACION

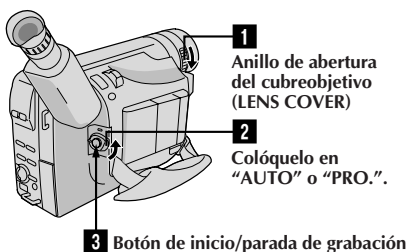

- 1 Gire el anillo **LENS COVER** de apertura/cierre para abrir el cubreobjetivo.
  - 2 Ajuste el interruptor de alimentación en "AUTO" o "PRO".  
— La lámpara de alimentación se encenderá y aparecerá una imagen.
  - 3 Presione el botón inicio/parada de grabación.  
— Comenzará la grabación.
- Para detener temporariamente la grabación, presione nuevamente el botón de inicio/parada de grabación. (Por más detalles, ☞ p. 16 y 17.)

**HOW TO LOCATE YOUR JVC SERVICE CENTER****TOLL FREE: 1-800-252-5722****Dear customer:**

In order to receive the most satisfaction from your purchase, read the instruction booklet before operating the unit. In the event that repair is necessary, or for the address nearest your location, please refer to the factory service center list below or within the Continental United States, call 1-800-252-5722 for your authorized servicer. Remember to retain your Bill of Sale for Warranty Service.

— JVC

**JVC SERVICE & ENGINEERING  
COMPANY OF AMERICA  
DIVISION OF US JVC CORP.**

## FACTORY SERVICE CENTER LOCATIONS

107 Little Falls Road  
Fairfield, NJ 07004-2105  
(973) 808-9279

5665 Corporate Avenue  
Cypress, CA 90630-4727  
(714) 229-8011

230 Eliot Street  
Ashland, MA 01721-2377  
(508) 881-5923

1500 Lakes Parkway  
Lawrenceville, GA 30243-5857  
(770) 339-2522

10700 Hammerly Blvd., Suite 110  
Houston, TX 77043-2310  
(713) 935-9331

8192 West State Road 84  
Davie, FL 33324-4611  
(954) 472-1960

705 Enterprise Street  
Aurora, IL 60504-8135  
(630) 851-7855

2969 Mapunapuna Place, Suite 101  
Honolulu, HI 96819-2000  
(808) 833-5828

890 Dubuque Avenue  
South San Francisco, CA 94080-1804  
(415) 871-2666

*Sophisticated electronic products may require occasional service. Just as quality is a keyword in the engineering and production of the wide array of JVC products, service is the key to maintaining the high level performance for which JVC is world famous. The JVC service and engineering organization stands behind our products.*

NATIONAL HEADQUARTERS  
JVC SERVICE & ENGINEERING COMPANY OF AMERICA  
DIVISION OF US JVC CORP.  
107 Little Falls Road  
Fairfield, NJ 07004-2105

***If you ship the product...***

*Pack your JVC unit in the original carton or one of equivalent size and strength. Enclose, with the unit, a letter stating the problem or symptom that exists and also a copy of the receipt or bill of sale you received when you purchased your JVC unit. Print your home return address on the outside and the inside of the carton. Send to the appropriate JVC Factory Service Center as listed above.*

**ACCESSORIES**

To purchase accessories for your JVC product, you may contact your local JVC Dealer.  
Or from the 48 Continental United States call toll free:  
1-800-882-2345.

**Don't service it yourself.****CAUTION**

To prevent electrical shock, do not open the cabinet. No user serviceable parts inside.  
Refer servicing to qualified service personnel.

## LIMITED WARRANTY

## CONSUMER VIDEO 1-90

JVC COMPANY OF AMERICA warrants this product and all parts thereof, except as set forth below ONLY TO THE ORIGINAL PURCHASER AT RETAIL to be FREE FROM DEFECTIVE MATERIALS AND WORKMANSHIP from the date of original retail purchase for the period as shown below. ("The Warranty Period")

PARTS	<b>1</b> YR	LABOR	<b>90</b> DAYS
-------	-------------	-------	----------------

THIS LIMITED WARRANTY IS VALID ONLY IN THE FIFTY (50) UNITED STATES, THE DISTRICT OF COLUMBIA AND IN THE COMMONWEALTH OF PUERTO RICO.

### WHAT WE WILL DO:

If this product is found to be defective, JVC will repair or replace defective parts at no charge to the original owner. Such repair and replacement services shall be rendered by JVC during normal business hours at JVC authorized service centers. Parts used for replacement are warranted only for the remainder of the Warranty Period. All products and parts thereof may be brought to a JVC authorized service center on a carry-in basis except for Television sets having a screen size 25 inches and above which are covered on an in-home basis.

### WHAT YOU MUST DO FOR WARRANTY SERVICE:

Return your product to a JVC authorized service center with a copy of your bill of sale. For your nearest JVC authorized service center, please call toll free: (800) 252-5722.

If service is not available locally, box the product carefully, preferably in the original carton, and ship, insured, with a copy of your bill of sale plus a letter of explanation of the problem to the nearest JVC Factory Service Center, the name and location of which will be given to you by the toll-free number.

If you have any questions concerning your JVC Product, please contact our Customer Relations Department.

### WHAT IS NOT COVERED:

This limited warranty provided by JVC does not cover:

1. Products which have been subject to abuse, accident, alteration, modification, tampering, negligence, misuse, faulty installation, lack of reasonable care, or if repaired or serviced by anyone other than a service facility authorized by JVC to render such service, or if affixed to any attachment not provided with the products, or if the model or serial number has been altered, tampered with, defaced or removed;
2. Initial installation and installation and removal for repair;
3. Operational adjustments covered in the Owner's Manual, normal maintenance, video and audio head cleaning;
4. Damage that occurs in shipment, due to act of God, and cosmetic damage;
5. Signal reception problems and failures due to line power surge;
6. Video Pick-up Tubes/CCD Image Sensor, Cartridge, Stylus (Needle) are covered for 90 days from the date of purchase;
7. Accessories;
8. Batteries (except that Rechargeable Batteries are covered for 90 days from the date of purchase); from the date of purchase);

There are no other express warranties except as listed above.

THE DURATION OF ANY IMPLIED WARRANTIES INCLUDING THE IMPLIED WARRANTY OF MERCHANTABILITY, IS LIMITED TO THE DURATION OF THE EXPRESS WARRANTY HEREIN.

JVC SHALL NOT BE LIABLE FOR THE LOSS OF USE OF THE PRODUCT, INCONVENIENCE, LOSS OR ANY OTHER DAMAGES, WHETHER DIRECT, INCIDENTAL OR CONSEQUENTIAL (INCLUDING, WITHOUT LIMITATION, DAMAGE TO TAPES, RECORDS OR DISCS) RESULTING FROM THE USE OF THIS PRODUCT, OR ARISING OUT OF ANY BREACH OF THIS WARRANTY. ALL EXPRESS AND IMPLIED WARRANTIES, INCLUDING THE WARRANTIES OF MERCHANTABILITY AND FITNESS FOR PARTICULAR PURPOSE, ARE LIMITED TO THE WARRANTY PERIOD SET FORTH ABOVE.

Some states do not allow the exclusion of incidental or consequential damages or limitations on how long an implied warranty lasts, so these limitations or exclusions may not apply to you. This warranty gives you specific legal rights and you may also have other rights which vary from state to state.

JVC COMPANY OF AMERICA      1700 Valley Road  
DIVISION OF US JVC CORP.      Wayne, N.J. 07470

REFURBISHED PRODUCTS CARRY A SEPARATE WARRANTY, THIS WARRANTY DOES NOT APPLY. FOR DETAILS OF REFURBISHED PRODUCT WARRANTY, PLEASE REFER TO THE REFURBISHED PRODUCT WARRANTY INFORMATION PACKAGED WITH EACH REFURBISHED PRODUCT.

### For customer use:

Enter below the Model No. and Serial No. which is located either on the rear, bottom or side of the cabinet. Retain this information for future reference.

**Model No.:** \_\_\_\_\_

**Serial No.:** \_\_\_\_\_

**Purchase date:** \_\_\_\_\_

**Name of dealer:** \_\_\_\_\_

EN

GR-AX840

**JVC**

VICTOR COMPANY OF JAPAN, LIMITED